

EPTAR
AI ARCHITERRA

PLUS



4.5

ArchiTerraPlus User Guide v4.5

Version for Microsoft Windows and Apple Macintosh

© 2024 Éptár Kft.

Copyright

The contents of this guide and the software described herein are the property of Éptár Kft. and copyrighted with all rights reserved.

Copyright laws prohibit the full or partial reproduction of the guide and software programs without the written permission of Éptár Kft., except in the normal use of the software to create a backup copy. This exception does not allow copies to be made for others, whether these be sold, loaned, or given away.

Guarantee Limitations

Although Éptár Kft. has tested the software described in the guide and reviewed its contents, Éptár Kft. provides no express or implied guarantee or statements regarding the software, its quality, performance, or fitness for any particular purpose.

As a result, this software is sold “as is,” and the purchaser assumes all risks in relation to its quality and performance.

In no case shall Éptár Kft. hold responsible for direct, indirect, special, incidental, or consequential damages arising from any defect in the software or errors in the guide, even if Éptár Kft. advised of the possibility of such damages.

In particular, Éptár Kft. shall not be liable for the loss of data or the software program from computers, including the costs incurred for recovering or reproducing the data or the program itself.

Licenses and Trademarks

ArchiTerraPlus is a registered trademark of Éptár Kft., Archicad, PlotMaker, topCAD and GDL are registered trademarks of Graphisoft.

Microsoft Windows, Windows 95/98/2000/NT/XP/10/11 are registered trademarks of Microsoft, Inc.

Apple, Macintosh, Power Macintosh and macOS are registered trademarks of Apple Computer, Inc.

AutoCAD, DXF and DWG are registered trademarks of Autodesk, Inc.

Other products and company names may be trademarks or registered trademarks of other companies and used purely for demonstrative purposes in favour of the trademark holder, without intent of breach.

Éptár Kft. HU-1145 Budapest

Szugló utca, 61-63.

Tel. (+36) 1 225 7355

Internet: www.eptar.hu

E-mail: info@eptar.hu

CONTENT

THE ARCHITERRAPLUS PLUG-IN	6
WORK METHODS	6
INSTALLATION OF THE SOLUTION	7
BUYING ARCHITERRAPLUS AND ONLINE ACTIVATION.....	8
ACTIVATION OF THE SOLUTION	8
THE TOOLBOX.....	10
IMPORT MULTIPLE TERRAIN DATA	11
TEXT FILE IMPORT (<i>MULTIPLE FILES IMPORT OPTION</i>).....	12
OVERWRITE ORIGINAL CODE.....	14
IMPORT RESULTS	14
DATA FROM DXF FILE (<i>MULTIPLE FILES IMPORT OPTION</i>).....	16
CORRESPONDENCE WITH THE DXF UNIT SYSTEM	19
IMPORT RESULTS	21
DATA FROM SHP FILE (<i>MULTIPLE FILES IMPORT OPTION</i>).....	21
CONVERTING ARCHICAD MESH INTO ARCHITERRAPLUS TERRAIN	23
POINTS TOOL.....	24
INSERT POINTS	24
EDITING POINTS	25
CONSTRAINT TOOL	26
OUTLINE TOOL.....	28
THE SEARCH CORRIDOR	29
OUTLINE ATTRIBUTES.....	30
CALCULATING TERRAIN	31
SHOW MORPHOLOGY.....	33
CONTOUR LINES TOOL	34
DRAWING CONTOUR LINES	34
CALCULATING CONTOUR LINES.....	36
COLOUR SLOPS OF MORPHOLOGY.....	38
EXPORTING THE DATA OF A TERRAIN TO A TEXT FILE	39
HOW ARCHITERRAPLUS TOOLS MODIFY THE TERRAIN	40

POLYLINE AND FILL TOOL	41
PLATEAU TOOL	42
SLOPED PLATEAU	46
MODIFYING PLATEAU	47
ROAD AND JUNCTION TOOL	48
CREATING A ROAD USING AN ARCHITERRAPLUS POLYLINE	48
NEW SETTINGS FOR ROAD:	50
CREATING A ROAD USING AN ARCHITERRAPLUS FILL	53
MODIFYING ROADS	55
CREATING ROAD JUNCTIONS.....	56
ROAD LONGITUDINAL SECTION TOOL	60
CONFIGURING LONGITUDINAL SECTION SETTINGS	62
MODIFYING ROAD LEVELS USING THE LONGITUDINAL SECTION.....	63
RAILWAY AND RAILWAY CROSSING	65
CREATING A RAILWAY USING AN ARCHITERRAPLUS POLYLINE.....	65
DITCH TOOL	68
CURB TOOL	72
BRIDGE / RAILWAY BRIDGE TOOL	74
PAVEMENT, SIDEWALK TOOL	79
MODIFYING PAVEMENTS	81
GRADIENT TOOL	82
RANDOM TREE GENERATION FUNCTIONS	84
CONFIGURING THE 2D TREE SYMBOL	88
CHANGING THE PARAMETERS OF A TREE ALREADY INSERTED	89
BASIN TOOL	90
BUILDING TOOL	92
MODIFY THE BUILDINGS	95
WALL TOOL	96
THE ALTITUDES OF ARCHITERRAPLUS WALL NODES	98
MODIFYING ARCHITERRAPLUS WALLS	100
RETAINING WALL TOOL	102
CREATING A RETAINING WALL.....	102
MODIFYING RETAINING WALLS	105
CREATING A RETAINING WALL AS AN OBSTACLE	106

COLOURED AREA TOOL	109
MODIFYING COLORED AREAS	111
MANAGING OVERLAPPING-COLOURED AREAS	113
MODIFY X-Y COORDINATES/MODIFY Z COORDINATE TOGGLE	115
CALCULATE TOOL	116
GRAVITY ON TERRAIN, INSERT OBJECTS	117
SPOT HEIGHTS TOOL	118
ATTRIBUTING SPOT HEIGHTS TO SURVEY POINTS	119
ATTRIBUTING SPOT HEIGHTS TO THE TERRAIN	121
CREATING MAPS WITH SPOT HEIGHTS.....	122
CAMERA TOOL	124
ARCHITERRAPLUS TOOL DEFAULT SETTINGS	127
HELP TOOL	128
APPENDIX	128
DATA UPDATE TOOL	129
UPDATING ALTITUDES	129
UPDATING ARCHITERRAPLUS WALLS	129
UPDATING THE ELEMENT PREVIEW	129
UPDATING A BASIN.....	129
UPDATING A ROAD LONGITUDINAL SECTION	129
UPDATING ALL ELEMENTS	130
ARCHITERRAPLUS LIBRARY ELEMENTS	131
FURTHER CHARACTERISTICS OF THE ARCHITERRAPLUS WALL	133
FENCE FUNCTION	134
GUARDRAIL FUNCTION.....	136
CUSTOMIZING TRUNKS AND LEAVES	138
TRUNKS	138
SPIRAL TRUNK	139
LEAVES	142
STAR FROND	144
PROBLEMS WITH SOLID ELEMENTS OPERATIONS	147
SOSI FILES IMPORT (MULTIPLE FILES IMPORT OPTION)	148
INDEPENDENT WORKSHEET	149
TERRAIN SURVEY TO SOSI FILE	151
CONVERT SOSI ENTITIES TO GDL OBJECTS.....	152

The ArchiTerraPlus Plug-in

Terrain Modelling

Work methods

Depending on the needs, work to define the terrain is essentially based on two different methods (although they are often used together).

Interactive manual insertion method

In this mode, the operator uses the ArchiTerraPlus basics (points, constraints, and contour lines) to plot the land morphology. In a common typical example, the user has a bitmap format digital map of the work area.

After correctly importing and scaling the image using the Archicad *Figure tool*, the map can be used as a reference base to “trace” the necessary data to describe the terrain (plotting altitude points, defining constraints and creating contour lines).

Manual mode can obviously also be used to define new terrain with the morphology required by the user.

Data import method

The user often already has a description of the terrain in electronic format (lists of points or DXF drawings) deriving from collaboration with surveyors or land survey studios.

In such a case, the model is created by importing these documents and automatically transforming the data they contain into ArchiTerraPlus primitives. During importation, it is however important to verify the compatibility of the formats received and if necessary, simplify the data by using the filters available in the ArchiTerraPlus import functions.

Installation of the solution

The ArchiTerraPlus Plug-in is available in Éptár website for Archicad in the versions 23, 24, 25, 26 and 27. To install the program, start the installation file and follow the instructions. The plugin will be included to Add-on folder of Graphisoft.

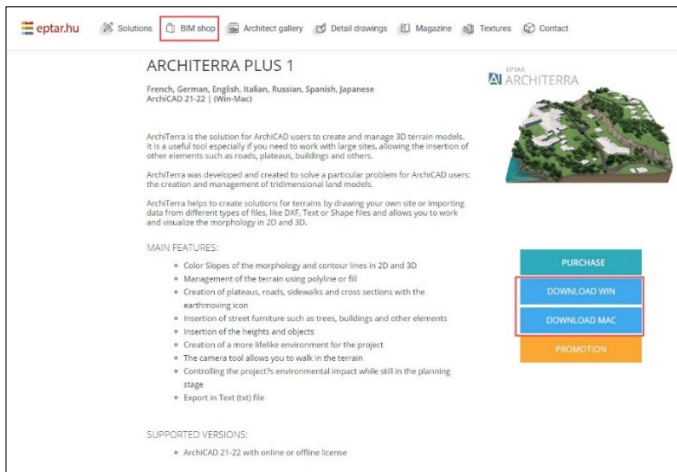

The screenshot shows the product page for ArchiTerraPlus 1 on the eptar.hu website. The page includes a navigation menu with links for Solutions, BIM shop, Architect gallery, Detail drawings, Magazine, Textures, and Contact. The main content area features the product title 'ARCHITERRA PLUS 1', supported languages (French, German, English, Italian, Russian, Spanish, Japanese), and the supported ArchiCAD version (21-22 | Win-Mac). A 3D rendering of a terrain model is displayed. Below the rendering are buttons for 'PURCHASE', 'DOWNLOAD WIN', 'DOWNLOAD MAC', and 'PROMOTION'. The page also lists 'MAIN FEATURES' and 'SUPPORTED VERSIONS'.

ARCHITERRA PLUS 1
French, German, English, Italian, Russian, Spanish, Japanese
ArchiCAD 21-22 | (Win-Mac)

ArchiTerra is the solution for ArchiCAD users to create and manage 3D terrain models. It is a useful tool especially if you need to work with large sites, allowing the insertion of other elements such as roads, plateaus, buildings and others.

ArchiTerra was developed and created to solve a particular problem for ArchiCAD users: the creation and management of tridimensional land models.

ArchiTerra helps to create solutions for terrains by drawing your own site or importing data from different types of files, like DXF, Text or Shape files and allows you to work and visualize the morphology in 2D and 3D.

MAIN FEATURES:

- Color Slopes of the morphology and contour lines in 2D and 3D
- Management of the terrain using polyline or fill
- Creation of plateaus, roads, sidewalks and cross sections with the earthmoving icon
- Insertion of street furniture such as trees, buildings and other elements
- Insertion of the heights and objects
- Creation of a more life-like environment for the project
- The camera tool allows you to walk in the terrain
- Controlling the project's environmental impact while still in the planning stage
- Export in Text (.txt) file

SUPPORTED VERSIONS:

- ArchiCAD 21-22 with online or offline license



The screenshot shows the 'ArchiTerraPlus 4.0 Setup' installer window. The title bar reads 'ArchiTerraPlus 4.0 Setup'. The window contains the EPTAR ARCHITERRA logo and a welcome message: 'Welcome to the ArchiTerraPlus 4.0 Installer'. Below the message, it states: 'This wizard will guide you through the installation of ArchiTerraPlus 4.0 - (2023-10-25). This wizard supports you installing the software. It is recommended that you close all ArchiCAD before starting Setup. Click Next to continue.' At the bottom, there are 'Next >' and 'Cancel' buttons.



The screenshot shows the 'ArchiTerraPlus 4.0 Setup: License Agreement' window. The title bar reads 'ArchiTerraPlus 4.0 Setup: License Agreement'. The window contains the EPTAR ARCHITERRA logo and the text: 'ÉPTÁR KFT. SOFTWARE LICENSE -TERMS AND CONDITIONS OF USE'. Below this, it says: 'Note for the User - please read attentively: THIS PRODUCT ENABLES THE USER TO USE THE BIM VERSION'. A note follows: 'Please review the license agreement before installing ArchiTerraPlus 4.0. If you accept all terms of the agreement, click I Agree.' At the bottom, there are '< Back', 'I Agree', and 'Cancel' buttons.

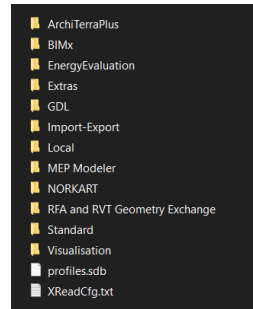
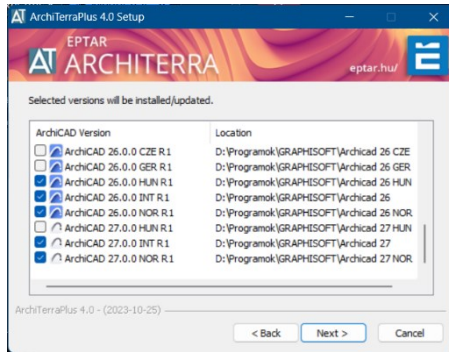

Buying ArchiTerraPlus and online activation

To start using ArchiTerraPlus properly, the add-on needs to be purchase and activated. In this case, you just need to follow a few steps in the Éptár website.

1. Register in <https://www.eptar.hu/>. If you already have a registration on the website, just login.
2. Once logged, go to BIM shop, and select ArchiTerraPlus.
3. To purchase, click on *Buy now* button. You can pay via PayPal, even if you do not own a PayPal account, you can still give the requested data and pay.
4. After purchasing ArchiTerraPlus, the product appears in your user account and on download page as well.

You can also purchase and ask to activate ArchiTerraPlus our partner in your country.

Activation of the solution

To activate the ArchiTerraPlus plugin your computer should have an active internet connection.

IMPORTANT:

The machine key is already NOT supported. During the next upgrade the machine key will be terminated and switched to online key option.

Online Key

After start ARCHICAD, in *EPTAR Solution* menu choose Registration in the *ArchiTerraPlus* button. Then follow the steps for Online Key Validation like in the pictures below.

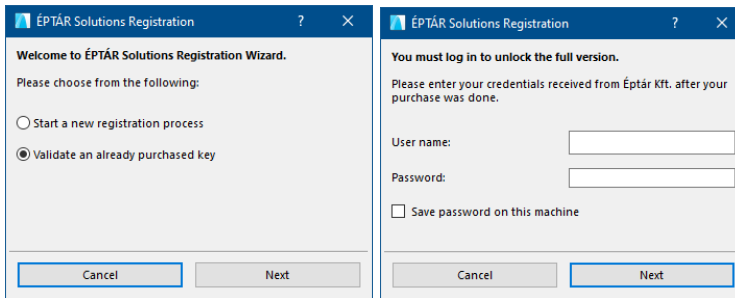

Borrowing the license

We present you a new option for online key. This option is not free, it is possible to buy for each license what you have. Buying it for one license it will work only with this license. How it's working:

- after you registered an ArchiTerraPlus online key open a Registration again
- click on "Next" button and if you receive a message "Congratulation!", your license is switched successfully to "offline" mode for 7 calendar days, that means you can use your license without online connection during a week. After the time is running out, the license switches back to online mode.

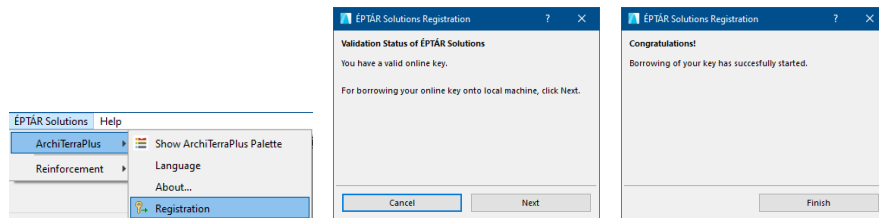

If you buy this option and it does not work, please contact to the ÉPTÁR support: info@eptar.hu

The Toolbox

ArchiTerraPlus toolbox is revised, now it is in Archicad style, and it is possible to dock vertically on left and right sides of Archicad work area. It is also divided in four phases of work and two additional procedures often used during the work.

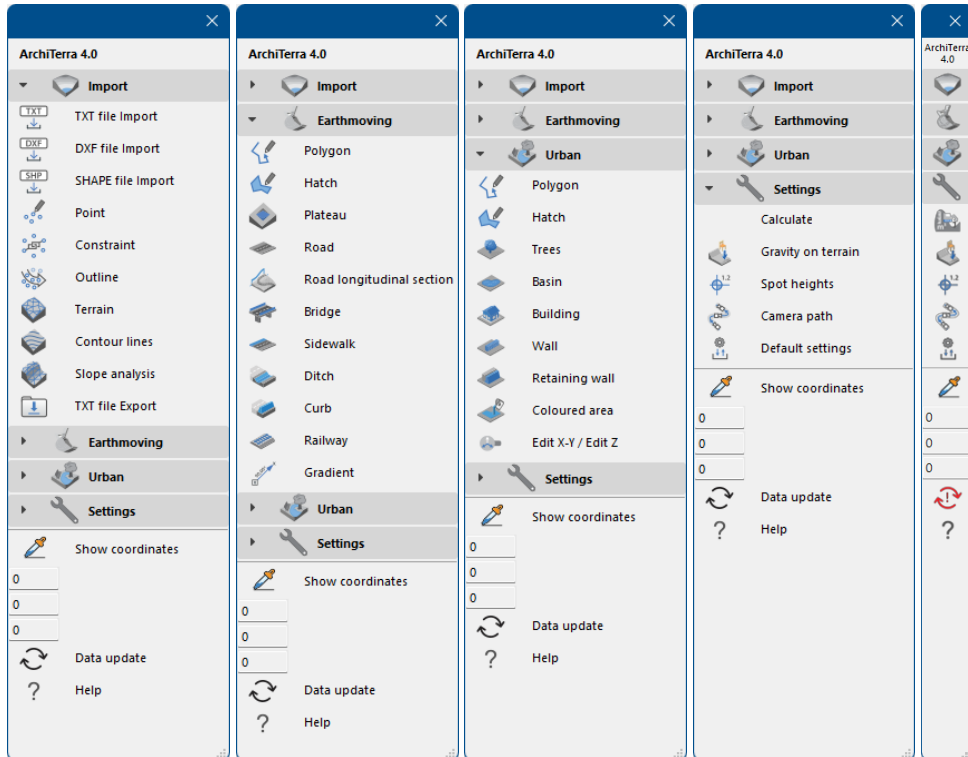

NOTE ON THE COORDINATES:

ARCHICAD does not allow us to continuously access the coordinates, so it was necessary to do a workaround. With the pick-up tool the user can temporarily approach the coordinate system and examine the terrain heights but must do a click to exit the procedure. Anyway, choosing this way, it gave on top of that the possibilities to examine the heights on working fields as well – therefore not only the meshes.

Import multiple terrain data

Below of this section all import methods will be explained in detail. But before starting the import, some new information about it:

- against of earlier version, the v4.0 can import and handle not only one terrain data file.
- the import should be done step by step:
 - o import one terrain file as the import is explained in next section (TXT, DXF, SHP, etc), and create an outline, then create the terrain model
 - o import the second terrain data file (TXT, DXF, SHP, etc)
 - o when you want to create the outline of second terrain, the program asks, what to do with previous outline: substitute it or keep it. If you keep it, the second terrain outline will NOT be created.
 - o selecting the "Substitute" option, the program will delete the first outline, and creates the new one for second terrain.

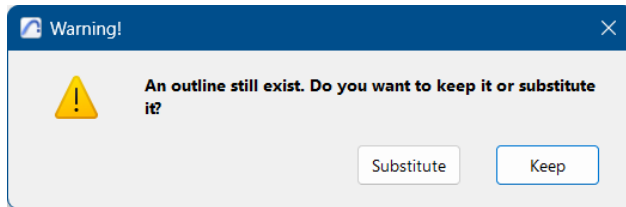

- o clicking on Terrain tool the second terrain object will be created
- this import process can be repeated as many times you'd like to do.

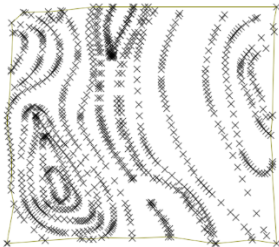

Text File Import (multiple files import option)

To import a list of points, click on the *Import TXT icon*.

ArchiTerraPlus displays a standard Open dialog box where the user can locate and select the text document to import.

ArchiTerraPlus immediately displays the *Text file import dialog box* to configure importation of the file. The preview area at the top shows the contents of the first lines of the text file.

The options box can be used to configure a number of characteristics for the import to be performed:

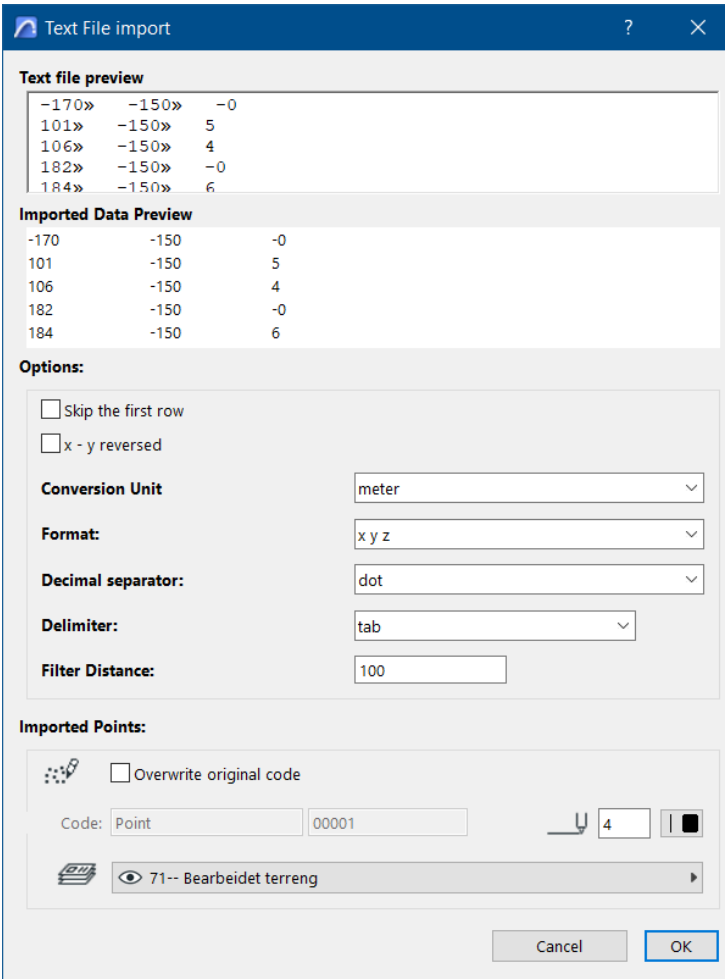

Text file preview

-170»	-150»	-0
101»	-150»	5
106»	-150»	4
182»	-150»	-0
184»	-150»	6

Imported Data Preview

-170	-150	-0
101	-150	5
106	-150	4
182	-150	-0
184	-150	6

Options:

Skip the first row

x - y reversed

Conversion Unit: meter

Format: x y z

Decimal separator: dot

Delimiter: tab

Filter Distance: 100

Imported Points:

Overwrite original code

Code: Point 00001

71-- Bearbeidet terreng

Cancel OK

Skip the first row.

Often the first row of a text file is explanatory, giving the names of the subsequent fields. Activating this checkbox avoids importing these data.

Reverse x-y

When the last checkbox (**reverse x-y**) is activated, the import order of the two X and Y coordinates is inverted.

Format

In a popup menu will be defined the order of the coordinates.

Decimal separator

The user can choose between separators (dot or comma).

Delimiter

In most of cases, the delimiter used is a TAB, but it can be chosen between appropriate delimiters.

Tab: There is one TAB between each field.

Semicolon: There is one “;” between each field.

Three or more spaces: There are at least three spaces between each field (or any greater number).

Other: When this option is activated, the text field on the right is enabled for the user to enter the required delimiter character (when this is not shown above).

IMPORTANT:

If ArchiTerraPlus refuses to import the selected text file, the user can try to open the file using a simple electronic spreadsheet to verify the arrangement of the contents of the fields within the individual cells.

Filter Distance

This field is used to define filter distance in order to avoid importing excessively close points.

TIP:

The simpler the mesh, the better ARCHICAD's performance will be. Mesh with more than 7000 points (obviously this value depends on the hardware configuration) slows down ARCHICAD and all operations associated with 3D view considerably.

The Imported Points box can be used to define particular options for the points (hotspots containing additional information) to be inserted in the ARCHICAD worksheet.

Overwrite original code

When the user activates this checkbox, the two fields below can be used to define the data, creating a personal code to be assigned to each imported point (overwriting any data already present), where the first field takes an optional alphanumeric string (max 20 characters) and the second, a progressive number. The code will be a combination of these data.

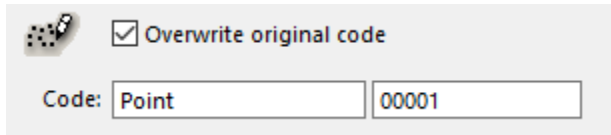

The image shows a user interface element with a checkbox labeled "Overwrite original code" which is checked. Below the checkbox are two input fields. The first field is labeled "Code:" and contains the text "Point". The second field contains the text "00001".

Import results

After reading the contents of the text file, ArchiTerraPlus displays the *Import Results dialog box* showing the results of the import operation performed.

The Imported Points section lists the number of points contained in the original text file, the number of points imported into the worksheet and the number of points skipped.

The difference between the points imported and the points read depends on the configuration of the Filter option.

If the number of points imported is excessively large (a warning image appears on the right), the user can click on the "Import Again..." button to return to the previous dialog window and change the filter value to simplify the number of data to be imported. In the Terrain Location area there will be the X-Y coordinates of the two corners (bottom left and top right) of the rectangle containing the terrain to be imported.

If the relief is georeferenced, the position of the terrain could be very distant from the ARCHICAD origin, and this could cause view and processing problems.

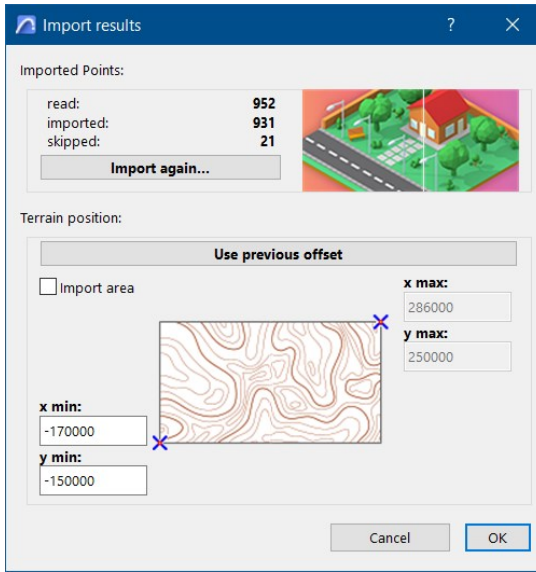

This can be resolved by using the two fields below in the Terrain position section to shift the data and reposition them near the origin: Delta X and Delta Y are the two values used to position the terrain.

Negative values will produce a shift towards the left and downwards, while positive values produce a shift towards the right and upwards.

IMPORTANT:

Do not undervalue this characteristic. Terrain distant from the origin could cause various problems during use of ARCHICAD.

The last section at the bottom, Import area enables the user to import part of the data only, defining the limits using the four coordinates below:

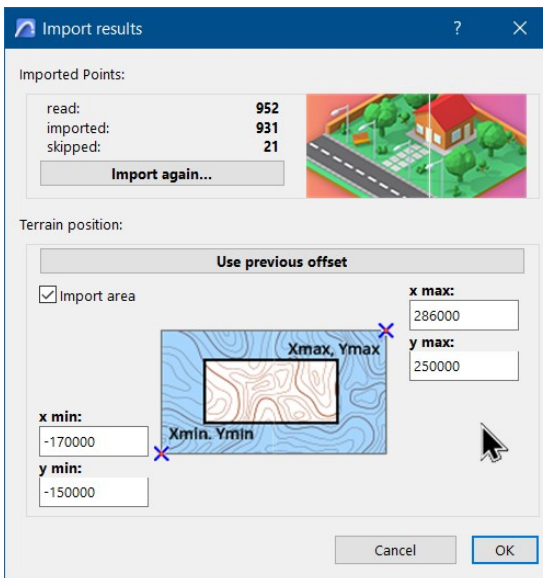

When this option is activated, it allows to import an area which the user can define, through the four activated fields (Xmin, Ymin, Xmax and Ymax).

Data from DXF file (*multiple files import option*)

DXF (Drawing eXchange Format) was developed by Autodesk for data exchange between different CAD programs.

ArchiTerraPlus reads DXF in text format (the most common) but is not compatible with DXF binaries.

A DXF drawing is structured in layers (as with ARCHICAD) and all graphic information is contained in the different original layers.

ArchiTerraPlus reads and imports the following primitives from DXF drawings:

Point: Point-type primitive, generally used to describe a typographic point.

Line: Line-type primitive.

Polyline: Polyline-type primitive, a split line made up of a series of consecutive segments.

Lwpolyline: Polyline-type primitive, a split line made up of a series of consecutive segments with a thickness configuration.

Spline: Primitive describing a curve (similar to ARCHICAD splines).

IMPORTANT:

ArchiTerraPlus cannot import DXF blocks (the equivalent of ARCHICAD library parts). If the survey points have been created using such blocks, they cannot be imported.

An important rule to always remember is that the aim is to import ONLY the information useful to describe the terrain. Therefore, the user should use the layer hierarchy in the DXF document with care and only import from the useful layers: the rest can be imported using ARCHICAD if necessary.

The terrain is mainly defined through points (nodes) and graphic primitives describing contour lines, which could also be identified as constraints, determining the way in which the triangulation is mapped.

TIP:

Before use ArchiTerraPlus to import DXF, the user can ask the supplier for a table describing the function of the layers and the type of information they contain. If this is not available, first import the DXF file using ARCHICAD and check which layer contains the primitives that wish to import. Take note of these layers and import the DXF file again using ArchiTerraPlus, activating only the layers in question.

NOTE:

Always remember that the DXF document **MUST** contain three-dimensional information, in other words, the terrain description must include a “Z” coordinate.

Click on the Import DXF File icon to import a DXF drawing.

ArchiTerraPlus immediately displays a standard open dialog box where the user can locate and select the DXF document to import.

Then ArchiTerraPlus will display the *DXF File Import dialog box*:

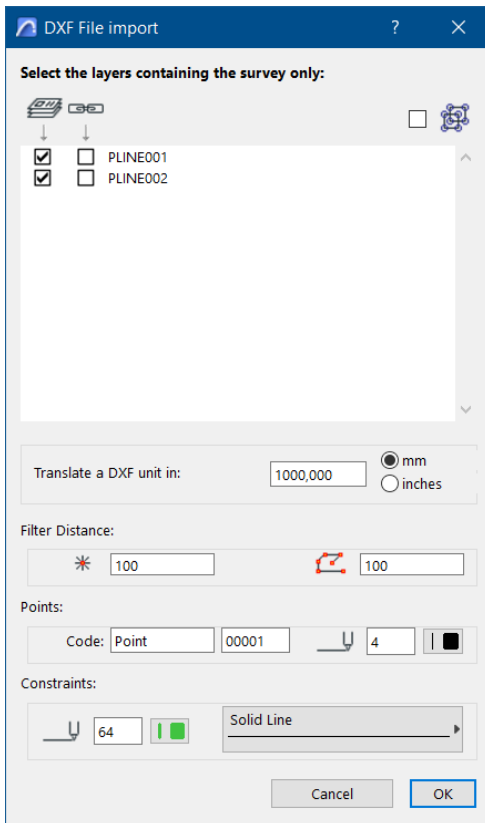

The central area displays a list of all layers.

There are two checkboxes next to each name regulating the treatment of the layer in question.

The first Import from Selected Layers checkbox activate/deactivates the layer import. Information contained in the layer will only be imported if this box is ticked, otherwise the information in the layer will be ignored.

The second (Create Constraints) checkbox determines how to import the graphic parts of the layer.

If the checkbox is not ticked, ArchiTerraPlus imports the primitives by simply reading the extreme coordinates and inserting ArchiTerraPlus points/hotspots in their place.

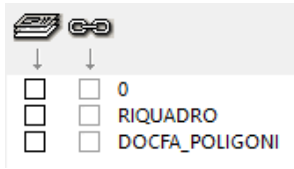

Therefore, if the layer contains lines (such as contour lines), ArchiTerraPlus only imports their altitude, placing points/hotspots at each end.

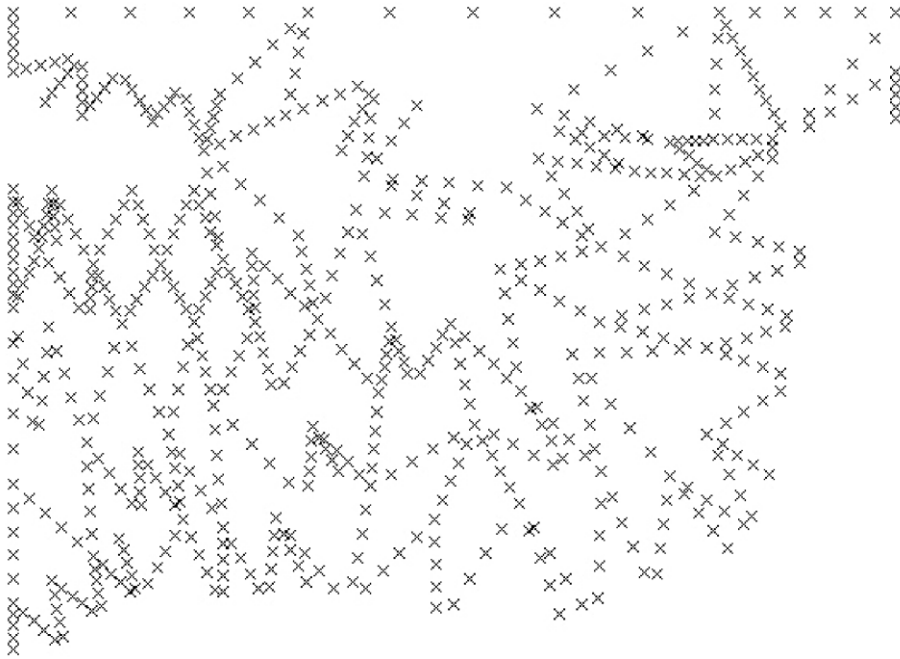

When the box is ticked, ArchiTerraPlus also imports the graphic primitives, transforming them into ArchiTerraPlus constraints (the description of the constraint tool is further on).

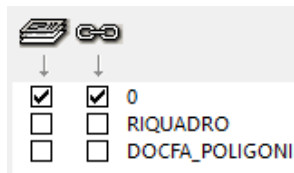

The result of the import will be a series of points/hotspots connected by constraints.

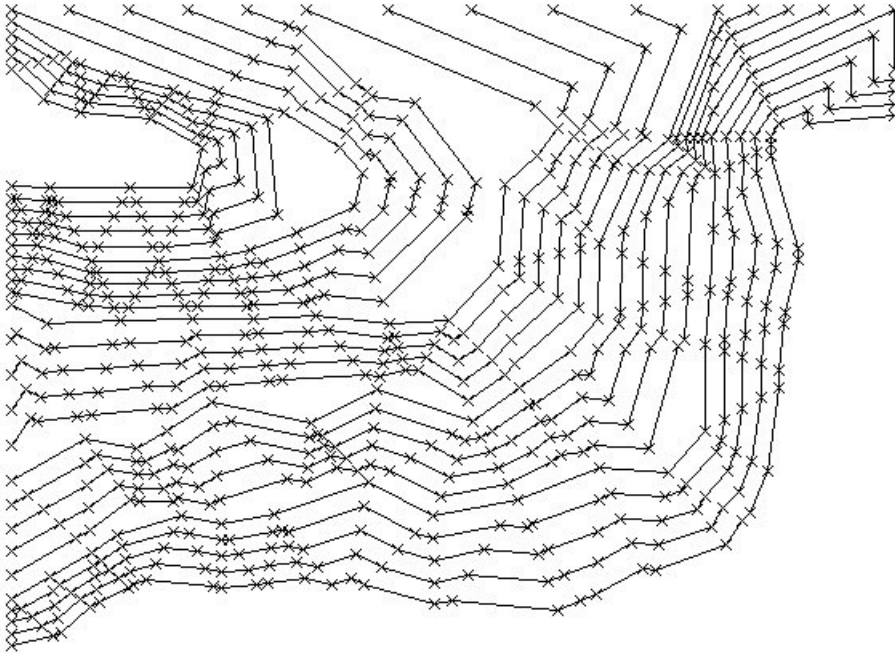

In this case (Create Constraints) it is useful to group together elements imported from the same primitive: for example, all points and constraints deriving from the same polyline.



Tick the check-box Group in the upper right part of the window to group these elements together.

TIP:

By clicking on the two icons in the upper part of the layer list window (icon with layers and icon with chain) it ticks all check-boxes for all the layers listed with a single click.

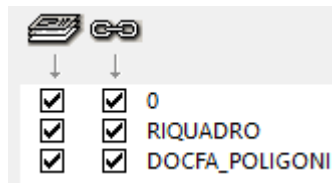

The two icons correspond respectively to the commands:

- Import from all layers.
- Create constraints from all layers.

Correspondence with the DXF unit system

Under the list of layers, users can define the unit system for the DXF drawing as do for ARCHICAD (for further information on the concept of unit systems, refer to the ARCHICAD DXF-DWG Conversion Guide).

Filter Distance

The instructions given above for importing text files is even more indispensable for DXF models.

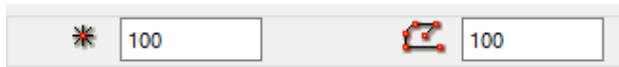

These two fields are similar to those used to import lists of points (TXT Files), allowing to simplify

data in the import phase. The distance set is used to filter the points imported. Points falling within this distance are deleted and not imported.

NOTES:

As seen above, users can also set the filter after the first reading of the file, as it will probably not know at the beginning how many points are in the file to be read.

The first value, on the left, defines the filter distance for importing points and works exactly as described for text file imports.

The second value is used to simplify polylines. By setting an adequate distance, it can considerably simplify a polyline of thousands of points without losing any important information in the description of the morphology.

Points

In this section, the user can use the two fields below to define data to create their personal code to be assigned to each imported points.

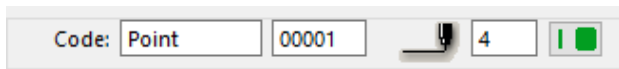

The first field takes an optional alphanumeric string (max 20 characters) and the second, a

progressive number. The code will be a combination of these data. Immediately on the right, it can be chosen the pen to represent the imported hotspots.

Constraints

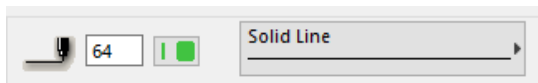

In this section, define the pen and line type used to represent the constraints/lines imported.

NOTES:

When importing data from DXF drawings, do not have to select any layer for the imported primitives as they will be stored in the same layers as in the DXF drawing.

Import Results

After reading the contents of a DXF drawing, ArchiTerraPlus displays the *Import Results dialog box* similar to the TXT described before, showing the results of the import operation performed and enabling users to make additional settings to optimize the results of the DXF drawing.

Data from SHP file (*multiple files import option*)

SHP or Shape file format is a geospatial vector data format for geographical information system (GIS) software.

ArchiterraPlus reads this data and convert it into 2D and 3D element.

Click on SHP icon in the ArchiterraPlus toolbar the “Import shapefile” window appears, and there are two options:

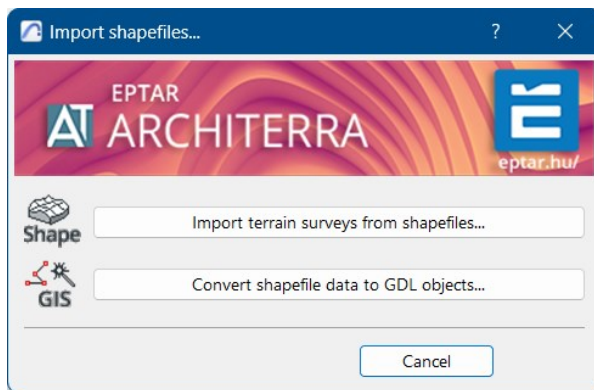

Import terrain surveys from shapefiles...:

- clicking on this option the Open window appears, where you can find the required SHP file. Select it and click on Open button.
- the Import results window appear where you can see how many points are imported, and you can set the Origin, if necessary.
Note: if the imported data will be placed too far from the Archicad origin, then it is possible some anomalies can appear. It is because the Archicad has some limitations in it. Depending on your request, it is supposed to set the “X min” and “Y min” values for zero or near of it.
- click on OK, and the import process starts.

- after the import is finished, all points are visible on the floor plan, and you can convert it to the necessary terrain model.

Convert shapefile data to GDL objects...:

- clicking on this option the Open window appears and you can select the file for import

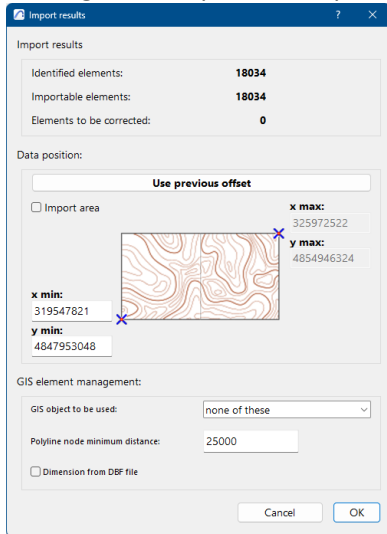

- then the Import settings appears again. Click on OK.
- In the next window you can select, what data will be imported for object

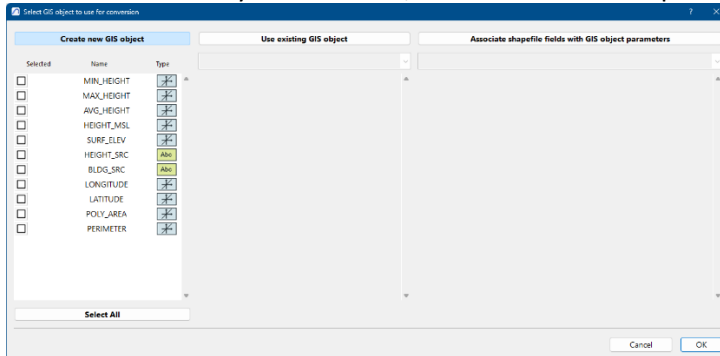

- in the next window you can give the name for this object, then click on OK.

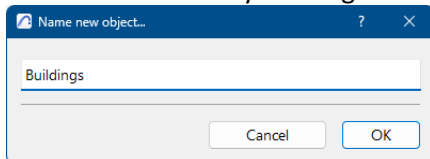

- all elements from the SHP data file will be converted to GSM objects.

Converting ARCHICAD Mesh into ArchiTerraPlus Terrain

From the version 4.5 the converting procedure is already not necessary. This version can use a simple Mesh of Archicad as a terrain model. As on the ArchiTerraPlus tools palette is visible, the “Transfer Archicad Mesh” tool icon is already missing. So, all described operation below is not necessary anymore.

~~This procedure can be used to convert a simple ARCHICAD mesh into an ArchiTerraPlus terrain/mesh. It will therefore be able to use all the tools provided by the program to modify your original mesh.~~

~~The procedure uses the following steps:~~

- ~~1. On the worksheet, select the ARCHICAD mesh to be converted.~~
- ~~2. Click on the Terrain tool in the ArchiTerraPlus toolbox and the program will display the *Mesh conversion dialog box*.~~
- ~~3. Click on Convert to transform the Mesh into ArchiTerraPlus Terrain.~~
- ~~4. Manage the changes in the terrain using the available tools in the ArchiTerraPlus toolbox.~~

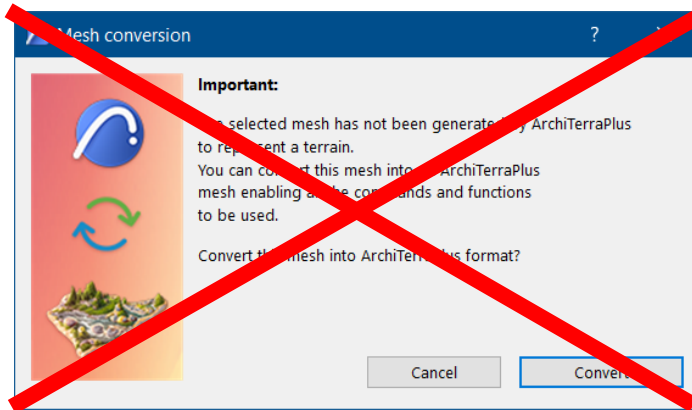

NOTE:

As far as in ArchiTerraPlus only one terrain at a time is able to exist, it is not possible to use this tool when there already exists a calculated terrain.

Points Tool

ArchiTerraPlus uses simple hotspots to represent the points, enabling complex terrains to be handled without overburdening. Do not confuse simple hotspots inserted using the relevant tool from the ARCHICAD palette with those inserted manually using the ArchiTerraPlus Points tool.

The hotspots inserted using ArchiTerraPlus contain added information - the altitude and identification code of the point.

There are two dialog boxes associated with this tool:

- One to edit the points/hotspots already included in the map;
- One to create/insert new hotspots.

Insert points

By clicking on the Point tool without selecting a point, the user start inserting points on the worksheet and ArchiTerraPlus displays the *Point settings dialog box*:

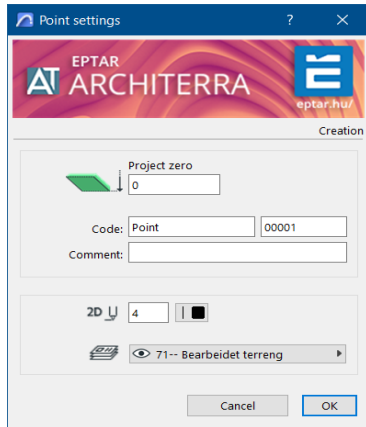

This starts the point insertion cycle and each time clicking on the worksheet, a new point with the characteristics defined in this box is inserted.

The following characteristics can be defined in the box and then associated with the ArchiTerraPlus points:

Code: As described above, an alphanumeric string and a number (increasing automatically) can be defined to identify the next point created.

Layer: From the relative pop-up menu, select the layer where the next point will be stored.

Project Zero: In this field it can be defined the Z coordinate of the point.

Pen: The pen to be used for the next point created on the ARCHICAD worksheet.

Editing Points

If one of the points already inserted manually or imported using the tools described above is selected and the user then click on the Point tool, ArchiTerraPlus will display the *Point settings dialog box* with the settings for the point selected:

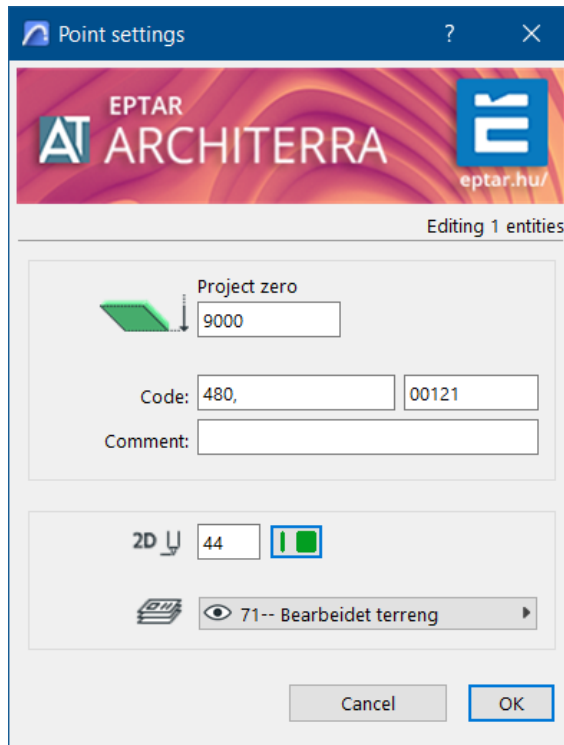

Point settings

EPTAR ARCHITERRA eptar.hu/

Editing 1 entities

Project zero
9000

Code: 480, 00121

Comment:

2D 44

71-- Bearbeitet terrene

Cancel OK

Despite the different layout, the information displayed is the same as that described above.

Constraint tool

Constraints are used to form the triangulation, linking two or more points following the specifications defined by the user.

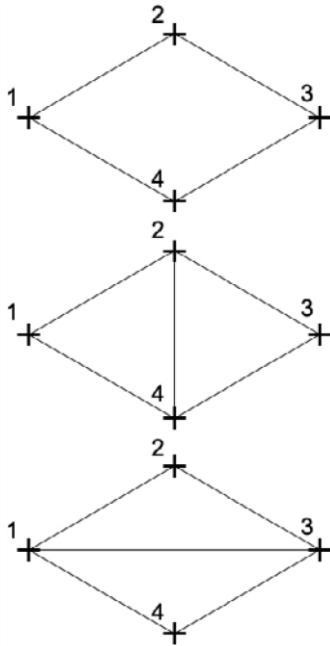

In the terrain processing phase, ArchiTerraPlus takes account of the constraints inserted, providing the triangulation requested.

Do not confuse the plain lines inserted using ARCHICAD and those transformed using ArchiTerraPlus. The last contain important information for terrain processing.

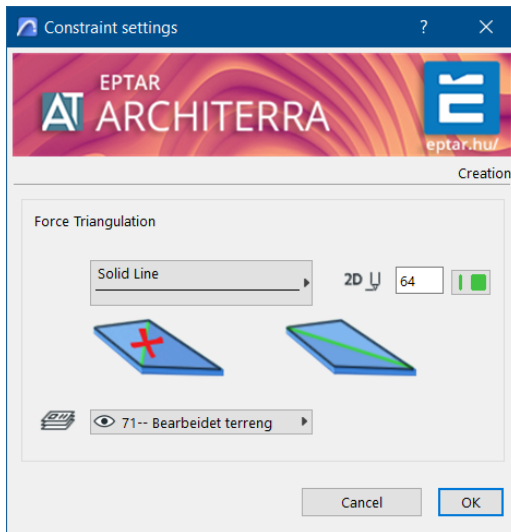

The *Constraint dialog box* offers the following options:

Line type: The type of line used to represent the constraint.

Pen: The pen used to draw the constraint.

Layer: The layer where the constraint is inserted.

To use the constraint tool, follow the steps below:

1. Click on the Constraints tool icon;
2. Configure the tool settings;
3. Confirm with the OK button;
4. Draw a polyline on the map joining the constraint points;

NOTE:

The Constrain tool is one of the few procedures where the instrument is activated after the OK.

Outline tool

Before generating the 3D terrain model, the user must first define its outline or external perimeter.

By clicking on the Outline tool, the *Outline settings box* will open, similar with the picture below.

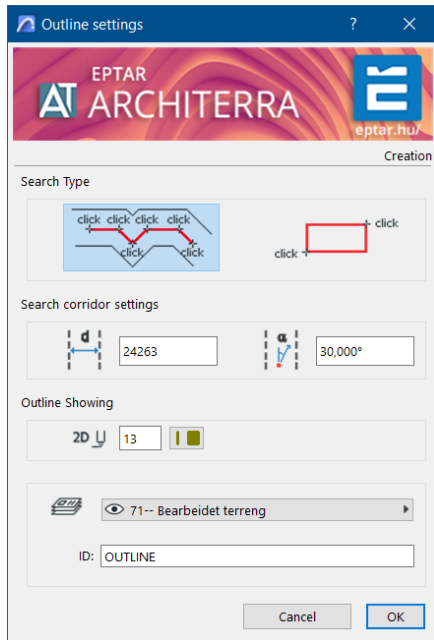

The drawing option using the two buttons on the dialog box can be chosen to define the type of outline: polygon or rectangle.

The two procedures for manual outline drawing are:



Polygonal: With a polyline it draw a rough perimeter to define a search corridor, where the final outline will be calculated automatically.



Rectangular: It approximate the outline by a rectangle shape where ArchiTerraPlus will calculate the final outline.

The search corridor

Users can define the specific parameters for this procedure in the *Outline settings dialog box*.



d (distance between guidelines): determines the width of the search corridor.

Alfa (search angle): ArchiTerraPlus uses this information to select the next point to join to generate the outline.

In the first picture, point 3 could be connected either with point 4 or with point 5.

The size of the search angle determines the choice. With a small search angle, point 3 will be connected to point 5 as point 4 does not fall within the angle.

With a large search angle, point 3 will be connected to point 4.

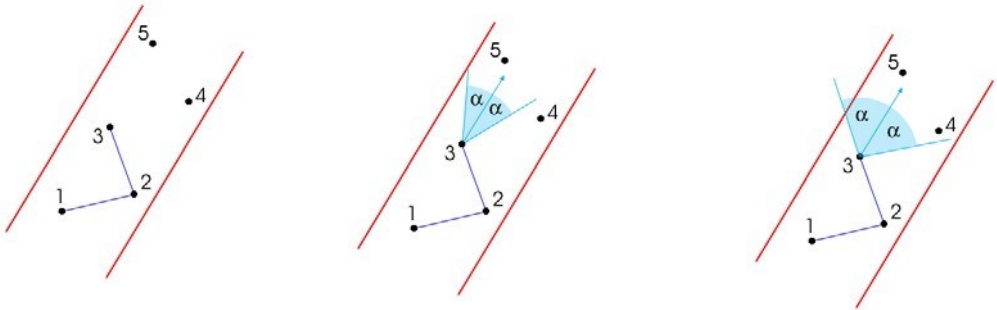

TIP:

Large angles produce uneven outlines, while small angles result in more linear outlines.

Outline attributes

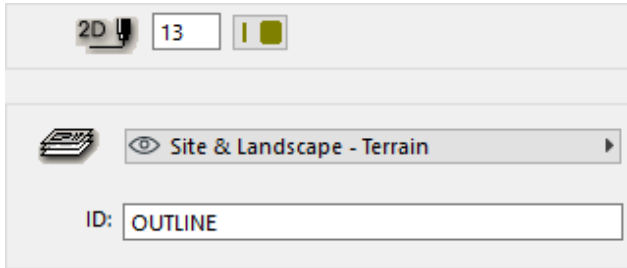

In the View section users can define the graphic appearance of the elements, such as the pen used for the edge (in the new interface) and the hatching and fill background (in the old interface which can be reached by clicking the button on the bottom left of the dialog box).

In the next part of the dialog box, a pop-up menu allows selecting the layer where the fill will be stored and at the bottom, the Listing Attributes section allows defining an alphanumeric string to identify the outline.

Calculating Terrain

This tool enables users to start work on the terrain, modify the attributes of a terrain/mesh calculated previously.

After the data describing the land morphology has been defined, it will have a series of 2D primitives (points/hotspots, constraints/lines, outline/fill) on the ARCHICAD worksheet.

To calculate the terrain produced from this information click on the Terrain tool.

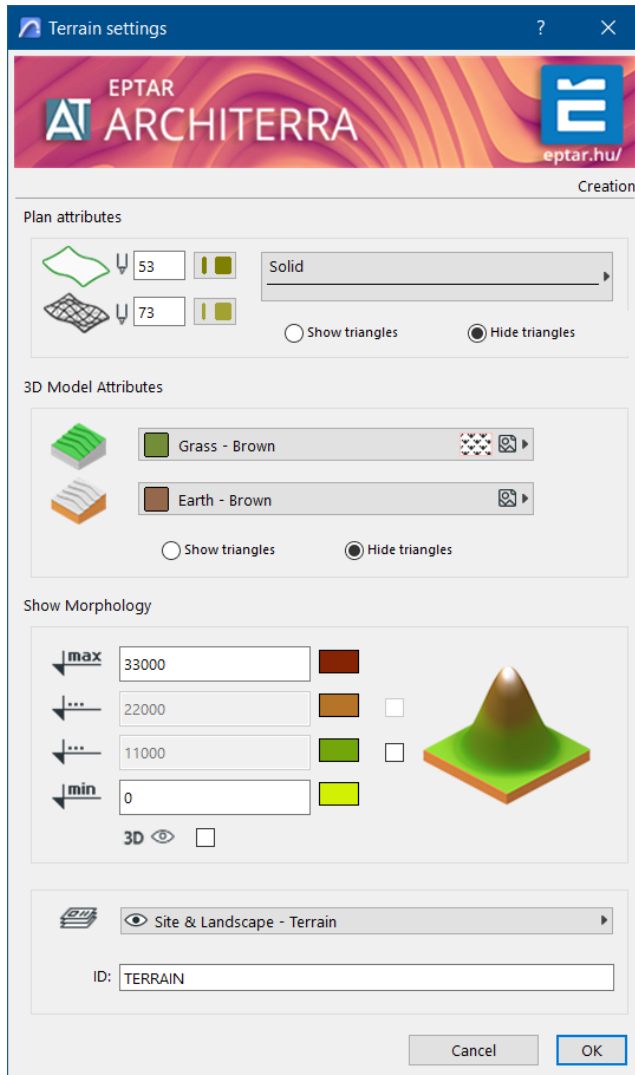

In the Plan Attributes section, users can configure:

- The type of line used to represent the terrain/mesh.
- The pen used for the terrain/mesh outlines.
- The pen used for the terrain/mesh edges.
- The two bottom radio buttons enable the terrain/mesh triangulation on the map to be shown/hidden.

In the 3D Model Attributes section, users can configure:

- The material for the top surface of the terrain/mesh.
- The material for the side skirt and bottom surface of the terrain/mesh.
- The two radio buttons on the right enable the terrain/mesh triangulation on the map to be shown/hidden in the 3D view.

In the Show Morphology section, users can configure:

- The minimum altitude of the terrain and colour for representation.
- The maximum altitude of the terrain and colour for representation.
- The radio buttons on the bottom that enable the morphology be shown/hidden in the 3D view.

In the Listing Attributes section, users can configure:

- The layer where the generated terrain/mesh is stored.
- An identifying code for the generated terrain/mesh.

When the configuration is confirmed with the OK button, calculation of the terrain begins.

Show Morphology

Use this tool to highlight differences in terrain altitude in the 3D view using a colour gradient defined by the user.

The four series of controls below define up to four colours to be used (a minimum of two) for each altitude defined in the numerical field on the left. In the interval between each pair of altitudes, a colour gradient is used which changes from the colour of the lower altitude to reach the colour of the top altitude. The result in the photo-rendering view will be as follows:

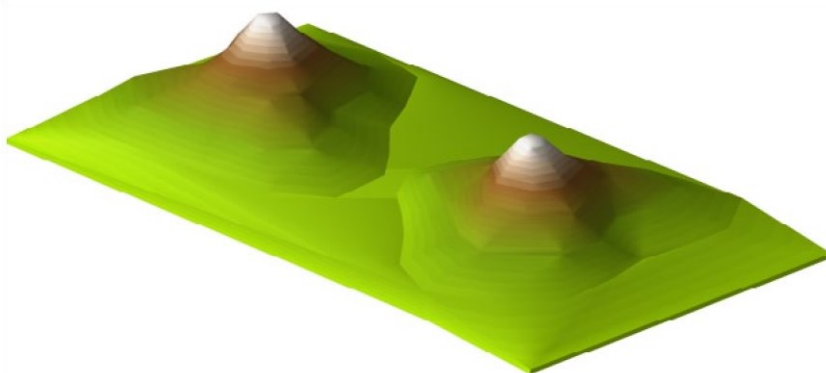

As explained above, users can use up to four different colours (a minimum of two) according to the status of the two check-boxes on the far right of the two lines included between the maximum and minimum altitudes:

max	-1323	<input type="color"/>	
...	-2021	<input type="color" value="#654321"/>	<input checked="" type="checkbox"/>
...	-2718	<input type="color" value="#4CAF50"/>	<input checked="" type="checkbox"/>
min	-3416	<input type="color" value="#FFFF00"/>	
3D		<input checked="" type="checkbox"/>	

Contour lines tool

The Contour Lines tool allows to define the morphology of the terrain model by indicating the course of the contour lines or calculating and displaying the contour lines on pre-existing terrain models.

Drawing contour lines

It normally need to draw contour lines when the user start to collect and define data to build a terrain model from scratch.

A scanner is most commonly used to digitalize the terrain map. Then, when the image is correctly imported and scaled in ARCHICAD, the contours on the map are recopied and transformed into ArchiTerraPlus information.

Drawing a contour line is extremely simple:

1. Draw a connected series of lines, arcs, polylines, and splines, then group them together.
2. Select the group of elements at the same altitude to transfer into contour lines.
3. Click on the Contour Lines icon in the ArchiTerraPlus toolbox and the program will display the *Contour Lines settings dialog box*:

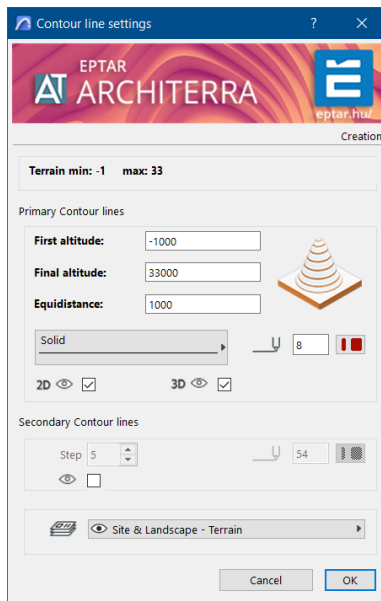

4. Configure the contour line parameters.
5. Confirm with the OK button.
6. ArchiTerraPlus transforms the selected elements, assigning them the necessary information to build the terrain.

The options in the dialog box to transform the two-dimensional primitives into contour lines are:

Altitude: The altitude of the contour line from the project zero.

Pen for points: The pen used to draw the points/hotspots deriving from transformation of the primitive into a contour line.

Pen for constraints: The pen used to draw the constraints/lines deriving from transformation of the primitive into a contour line.

Line type: The line type used to draw the constraints/lines deriving from transformation of the primitive into a contour line.

Layer: Where the points/hotspots and constraints/lines making up the contour line are stored.

IMPORTANT:

The primitive 2D curves will be transformed into contour lines using the current resolution settings of the ARCHICAD Magic Wand. This value should be appropriately configured to avoid generating excessively complex contour lines consisting of hundreds of thousands of nodes.

Calculating contour lines

The same tool in the ArchiTerraPlus toolbox is also used to calculate contour lines on previously drawn terrain/mesh.

In contrast with ArchiTerra3 the nomenclature has been changed to follow the ISO norms. The principal counter lines have a suggested equidistance of 1m and the Secondary counter lines have a proposed distance of 5m.

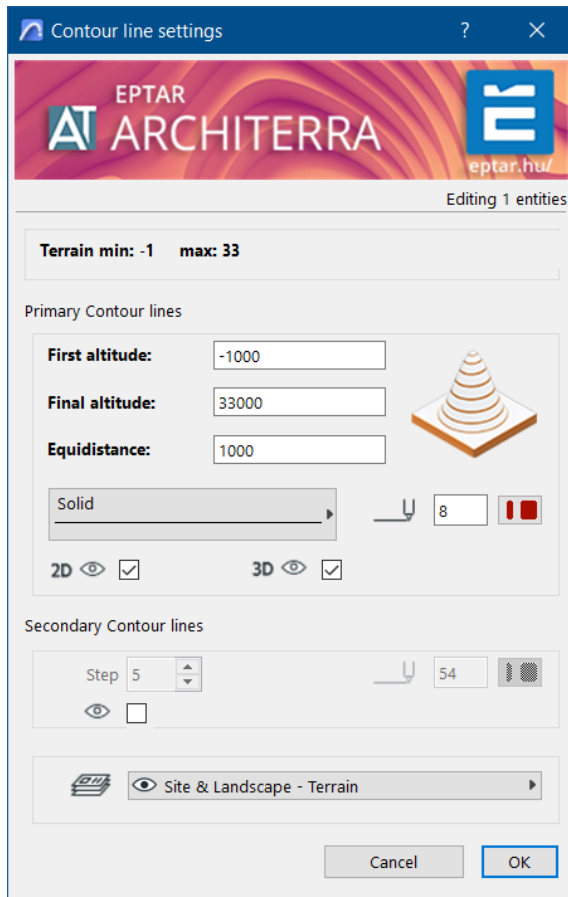

Principal Contour Lines

First altitude: The altitude from which to start calculating the contour lines (the default value that appears is the lowest altitude on the selected terrain).

Final altitude: The altitude where calculation of the contour lines should end (the default value that appears is the highest altitude on the selected terrain).

Equidistance: The spacing between contour lines.

Secondary Contour Lines

When this option is activated (check-box with an eye icon), secondary contours are displayed every given number of secondary contours as defined in the Step field. The pen selection field allows to graphically distinguish these contours from the secondary contours (configured in the section below).

View

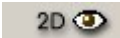
 The two check-boxes enable or disable contour line display in the Map view and in the 3D view.



NOTE:

An operation performed with ArchiTerraPlus that modifies the mesh morphology will automatically result in immediate updating of the Contour Lines object (if it has been calculated).

Colour Slops of Morphology

ArchiTerraPlus collects the triangles which have the same inclination in the slope and use the same colours.

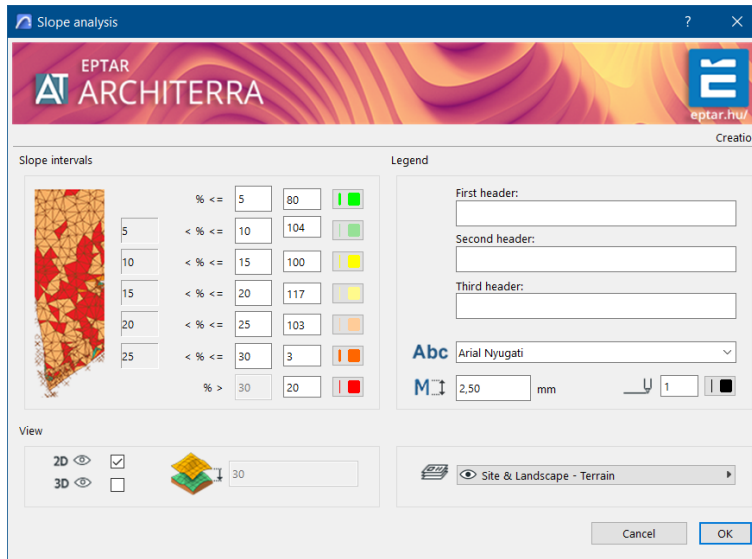

In this way the user can see the morphology of the Terrain also in 2D.

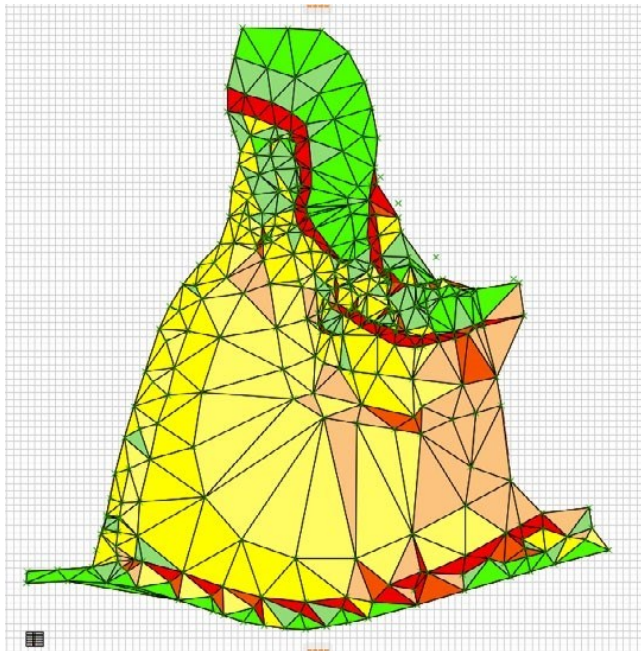

Exporting the data of a terrain to a text file

Once the procedure has been started by clicking on the icon, a standard save dialog box will open where it can be defined the name of the file to export and the location.

Then the *Settings dialog box* will open with some option before finishing the export.

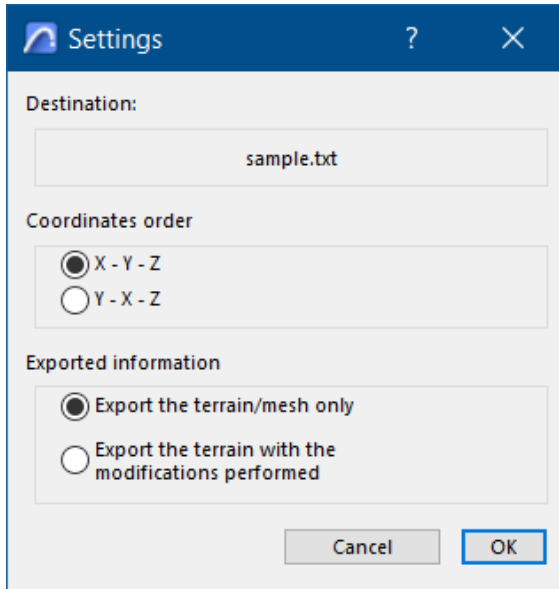

The Coordinates Order section allows to define the order in which the X and Y coordinates will be exported.

The Exported Information section allows to choose what to export:

- Export Terrain/Mesh only (only the morphology of the original terrain is saved).
- Export Terrain with Modifications (points deriving from modifications to the terrain with elements are also saved).

NOTE:

If there is no terrain created, but exist only points, the data cannot be exported.

How ArchiTerraPlus tools modify the terrain

Before describing the next tools in the ArchiTerraPlus toolbox, here are a few simple examples of how ArchiTerraPlus tools modify terrain.

Firstly, from this version of ArchiTerraPlus, modifications to the terrain (plateaux, roads, coloured areas and retaining walls) are performed using the Solid Elements Operations technique (Boolean operations).

The main advantage of this technique lies in the fact that all actions are parametric, in other words, the characteristics can be modified without losing the work carried out so far.

As all actions are now parametric, in the example given above, the level of the plateau, its shape or any associated parameter (such as the angle of the scarps or materials used) can be modified without problem.

The following image shows the profile of a terrain with a segment indicating the plateau we want to obtain:

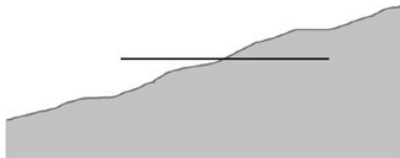

In practice, by modelling the terrain with ArchiTerraPlus we want to obtain the following results:

If we analyse the operation with the help of the following diagram, it can be seen that part of the terrain (the part on the right labelled 2) has been removed, while the other part (on the left with number 1) has been filled.



Considering the terrain as a solid and thinking in terms of Boolean operations, the solution to model the terrain in such a way as to obtain the required plateau would be as follows.

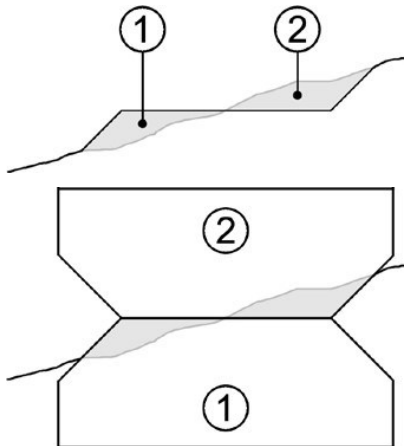

Solid number 2 is the solid which “excavates” and which will therefore be used in the Boolean subtraction. Solid number 1 is the solid which “fills” and which will therefore be used in the Boolean addition.

The two Boolean operations of subtraction and addition (excavation and fill) give the required results:



ArchiTerraPlus precisely uses this technique. As all ARCHICAD users will know, the solids used as operators cannot be cancelled (otherwise the solid operation is lost) but must be positioned on an invisible layer.

ArchiTerraPlus adopts the same logic, using a special layer named “AT_Operators” in which these two objects (the excavating object and the filling object) are stored, managed and suitably. A third object can be considered as the actual operation itself has a display and editing function only. In the case described above of a plateau, it simply displays the edge of the plateau and provides editable hotspots allowing users to drag the corners to modify the shape if required.

The three objects (excavation, fill and display) are intimately linked, and users do not need be concerned about which one are editing (although users in fact see and edit the display object only). When one is modified, ArchiTerraPlus automatically modifies the other two as well.

When the user selects the operation (in fact selecting the display object) and modify the configurations using the settings dialog box, ArchiTerraPlus will automatically modify and update all three objects.

IMPORTANT:

Do not change the layer of the ArchiTerraPlus objects used for terrain modelling or, if this is unavoidable, always use the ArchiTerraPlus dialog boxes, selecting the action and then clicking on the icon of the relative tool in the ArchiTerraPlus toolbox. ArchiTerraPlus will be able to manage display automatically only if the original layer is used.

Polyline and Fill Tool

ArchiTerraPlus uses often the *Polyline* or the *Fill Tool* as base for further elaboration. In an earlier Version of ArchiTerraPlus users had to use the commands from ARCHICAD. To facilitate the use, we included those procedures directly in ArchiTerraPlus and kept the use very similar.

Plateau tool

The fill used to identify the area to be levelled can include curved sides but not holes. If holes are present in the fill used, ArchiTerraPlus will not consider them.

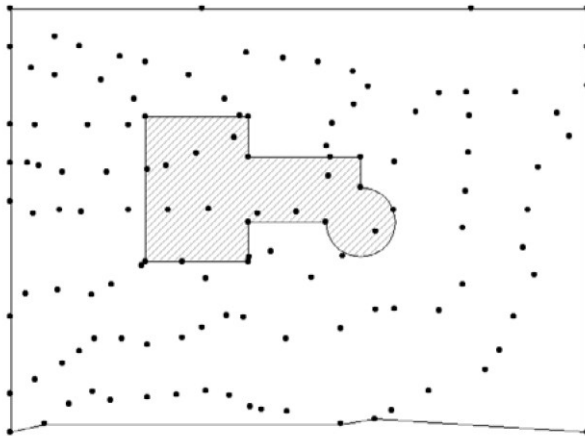

To create a plateau, first draw the perimeter of the area to be levelled using the fill tool and then select the fill to be processed.

Then click on the *Plateau setting dialog box* to start the procedure.

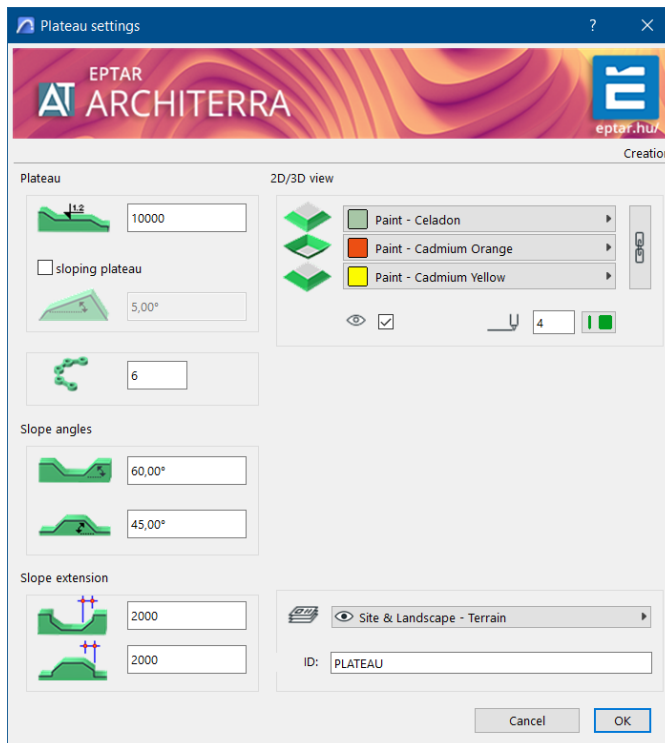

In the section at the top left labelled Plateau, it can be defined the height and type of the plateau, given that users can create either horizontal or sloped plateaux. In this example the sloped plane option is disabled and a plateau with a horizontal plane will therefore be created. How to create a plateau with sloped plane will be described in detail in the following paragraph.

The angle of the scarps created by the excavation or fill can be defined in the following section, Slope Angles.

A value for the length of the scarp can be defined in the Slope extension section immediately below.

Here is an example.

The following image shows a rectangular plateau, with correct scarps and reach the level of the terrain:



In a subsequent phase, the height of the plateau has been modified and raised appreciably. As can be seen from the following image, this graphic modification has left a block at the base where the original length of the scarp is no longer sufficient:

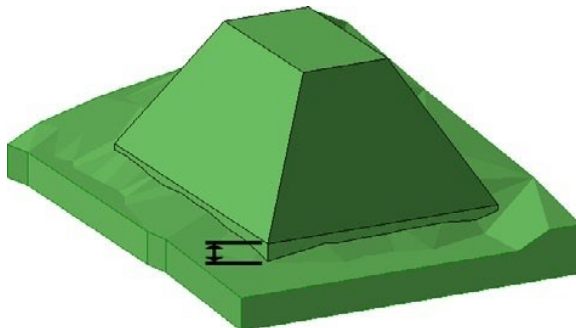

To avoid this problem, open the settings box by clicking on the icon of the relative tool in the ArchiTerraPlus toolbox and increase the scarp length value appropriately:

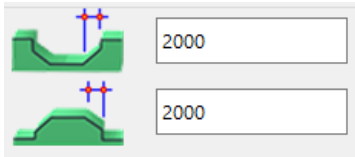

Confirm the modification and the excavation will be update and will again be correct.

In the 3D Model section of the Plateau settings dialog box, it can be configured the resolution of the curved parts and the three materials used for the surface of the plateau, the surface of the excavated scarps and the surface of the filled scarps.

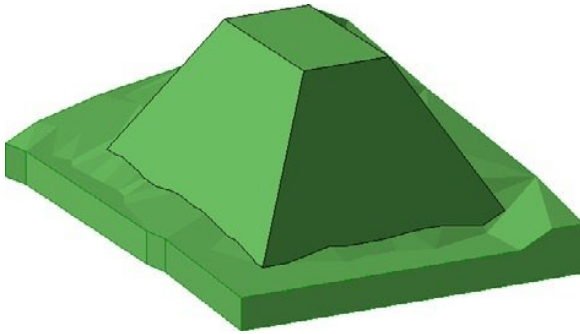

As a new feature that the slope angle of the plateau is possible to adjust separately on each side. When the plateau is selected, the purple hot spot appears on the slope side.

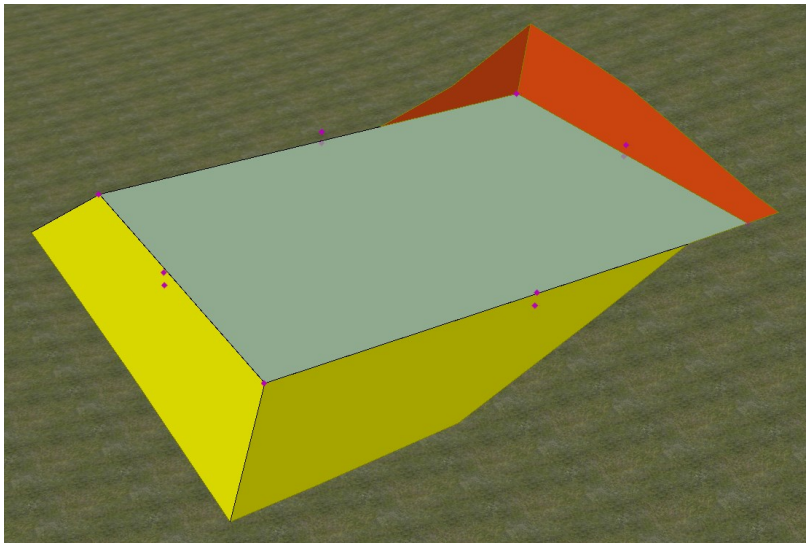

Click on this hot spot you can change the angle of slope graphically, or you can press the TAB button and write the required angle of slope, and hit the Enter.

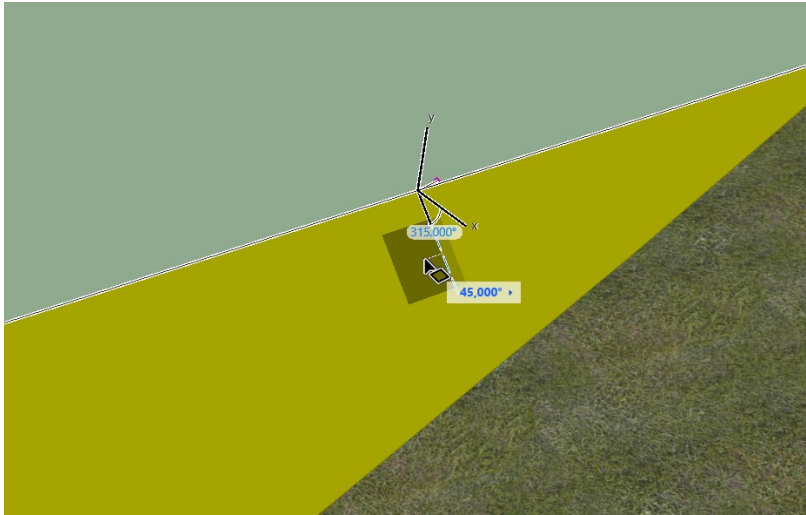

The slope will be modified immediately.

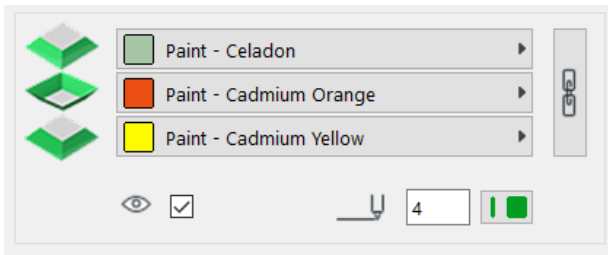

In the 2D/3D View section, users can configure whether the perimeter of the excavation will be displayed in the map view (by activating the relative check-box on the left) and the pens used to represent the edge of the excavation in the map and 3D views.

The ID field in the Listing Attributes section can be used to assign an identification string to the element in order to recognize it in the project lists to calculate the volumes of earth moved.

Sloped plateau

To create a sloped plateau, first draw the perimeter of the area to be levelled using the fill tool and then select the fill to be processed:

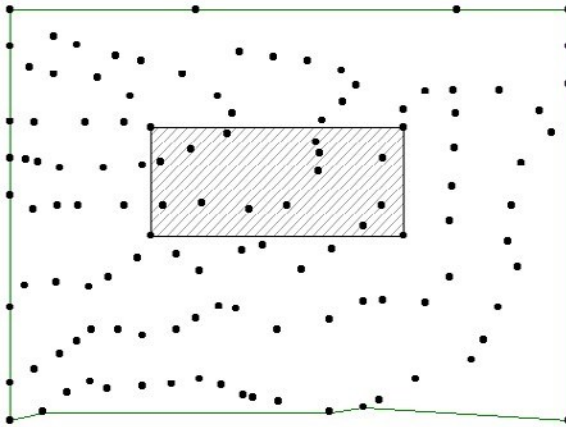

Then click on the Plateau tool to start the procedure. ArchiTerraPlus immediately displays the *Plateau settings dialog box* described above.

To create a sloped plateau, click on the sloped plane check-box in the Plateau section.

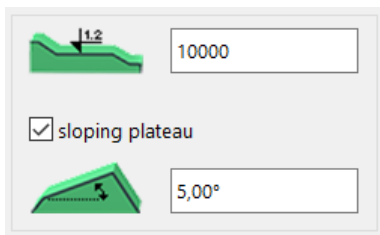

When the check-box is activated, the field below is enabled and it can be defined the slope of the plane. All other fields have the same function as described previously, configure as required and click on the OK button.

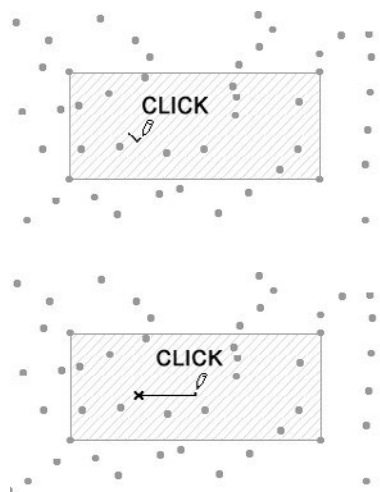

ArchiTerraPlus closes the box and changes the shape of the cursor into a pencil, waiting for a click to define a node of the plateau.

After clicking, the user must click again to define the vector (which starts from the previous node and ends at the next point indicated by the click) determining the slope direction.

After this second click, the sloped plateau is generated immediately:

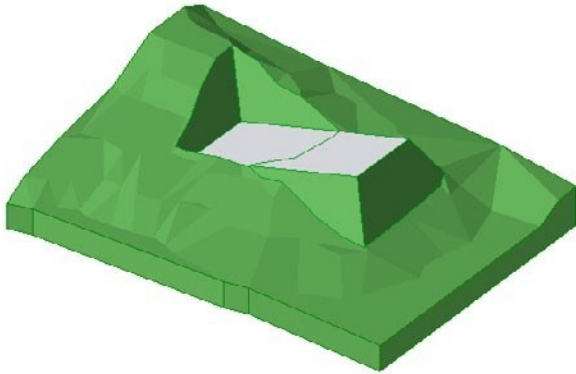

Modifying plateau

As already mentioned, these elements are parametric and can therefore be modified at any moment.

1. In the map view (or 3D view), select the element by clicking on one of the perimeter nodes.
2. Click on the nodes, drag them and release them in the required position as it would be to modify any ARCHICAD polygonal element (slabs, fills, etc).
3. After modification, click on the Data Update tool to update the preview of the element in the map view.

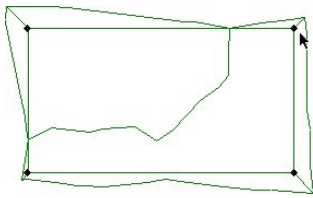

Selecting the element

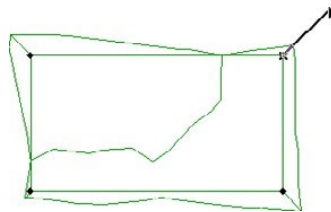

Moving the nodes

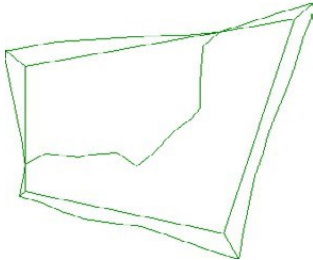

Updating the preview in the map view

Road and Junction Tool

There are two ways to create a road: Using an ArchiTerraPlus polyline or an ArchiTerraPlus fill.

Creating a road using an ArchiTerraPlus polyline

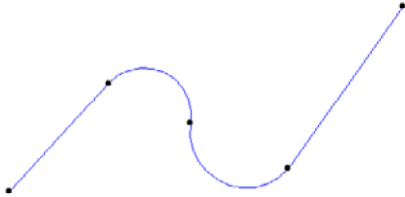

Using the *ArchiTerraPlus Polyline tool*, draw a polyline to create the center line of the road to be created.

NOTE:

The nodes of the polyline are extremely important as they define the variations in altitude of the element. ArchiTerraPlus uses these nodes to calculate the altitude of the element which will be rested on the ground with these coordinates.

Select the polyline and click on the Road tool in the ArchiTerraPlus toolbox to display the *Road settings dialog box*.

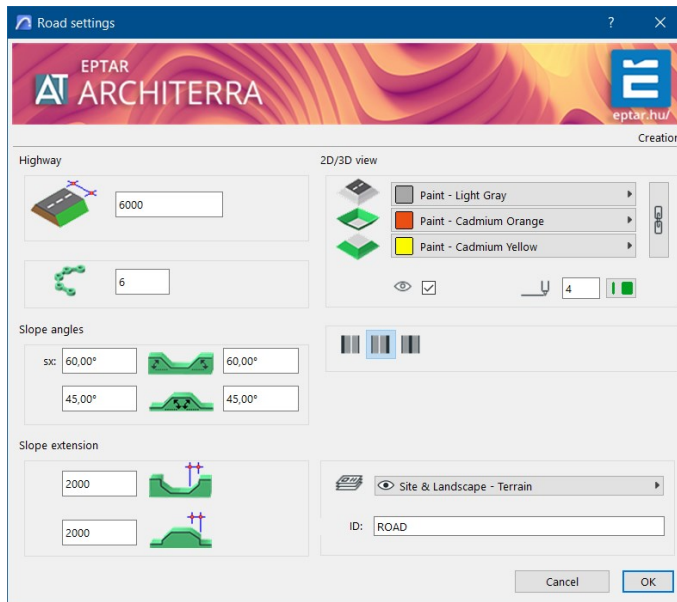

The first value in the Road section indicates the width of the carriageway. Use a polyline to create “regular” roads with a constant width (although by dragging the edge nodes, it can easily modify the shape afterwards).

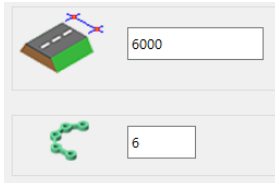

Immediately below in the Slope Angles section, four fields allow to define the angle of the excavated and filled scarps on the right and left of the road.



Below this, in the Slope extension section, it can be defined a value for the length of the scarps. These two values follow the same logic and have the function as described previously for the Plateau tool.

At the top right in the 3D Model section, the user can configure the resolution of the curved parts and the three materials used for the surface of the road and the surface of the excavated and filled scarps (the chain on the right enables the same material to be assigned to the three surfaces).

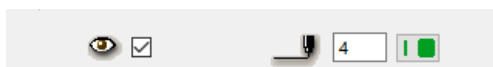

In the 2D/3D View section, it can be configured whether the perimeter of the road will be displayed in the map view (by

activating the relative checkbox on the left) and the pens used to represent the edge of the road in the map and 3D views.

The ID field in the Listing Attributes section can be used to assign an identification string to the element to recognize it in the project lists to calculate the volumes of earth moved. Lastly, the pop-up menu at the bottom right allows to define the layer where the element object is stored.

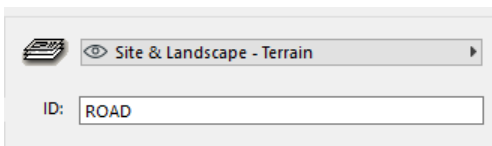

Confirm the modifications made to the settings using the OK button and ArchiTerraPlus will immediately process the road as requested.

After the road is placed there are some NEW settings available in the Road objects settings window. Select the Road object, open an Object Settings window.

New settings for Road:

- Road composite

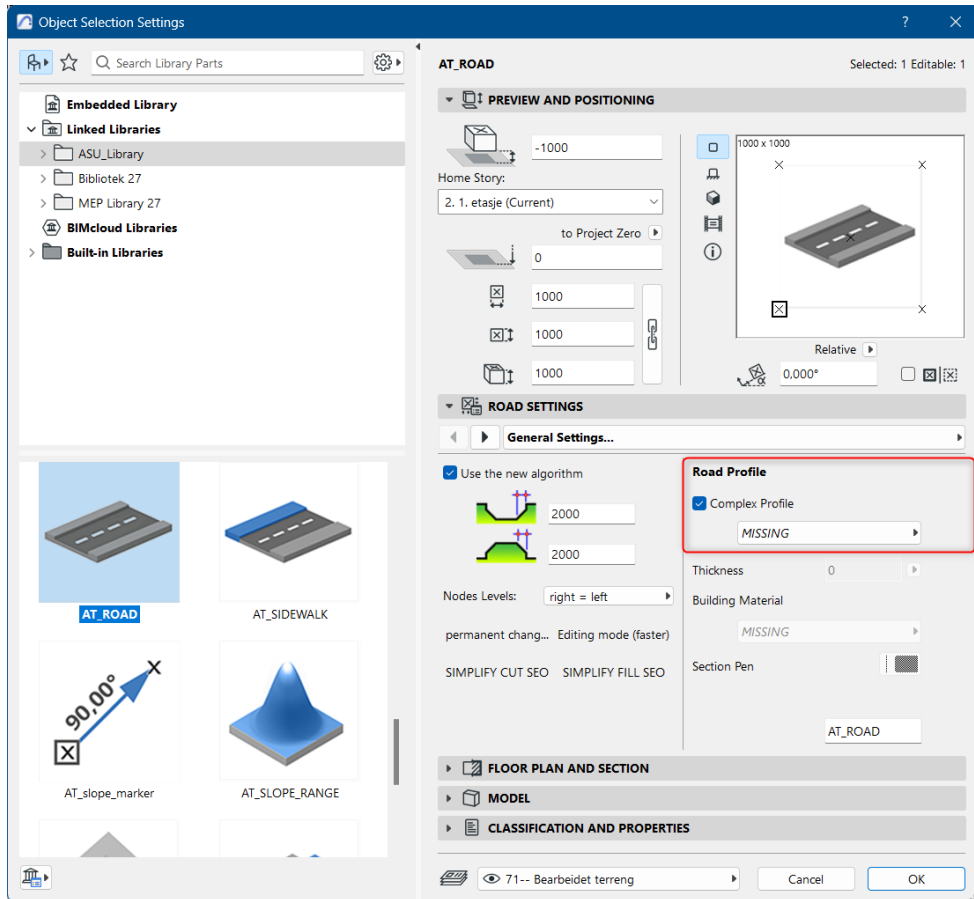

The composite, what could be used for road, is not predefined in Archicad, so it must be created in the Profile Manager by user.

How to set road composite?

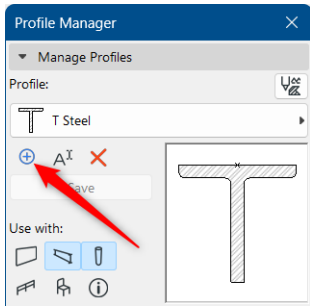

Open the profile manager, click on “+” sign. Give the name for this profile and save it into the existing or new folder in the profiles list.

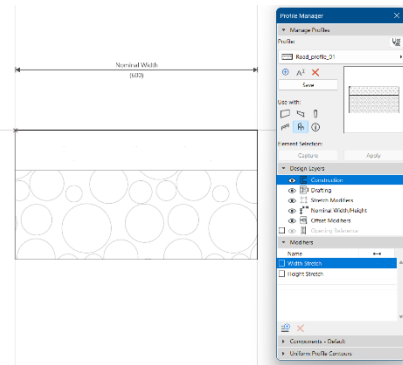

The next is to create the composite for road. Select the FILL tool and draw the rectangular. The upper point should be defined in the Origin. If the upper point defined higher, the road surface, where this composite will applied, will be elevated from the original level.

So draw the first layer with the FILL tool. Then define under this some other according to the requirement. After it select the placed fills step by step and define the Building Material for each. When it is done, select

the element group, where this composite can be used for. In our case it is only the “Object” group.

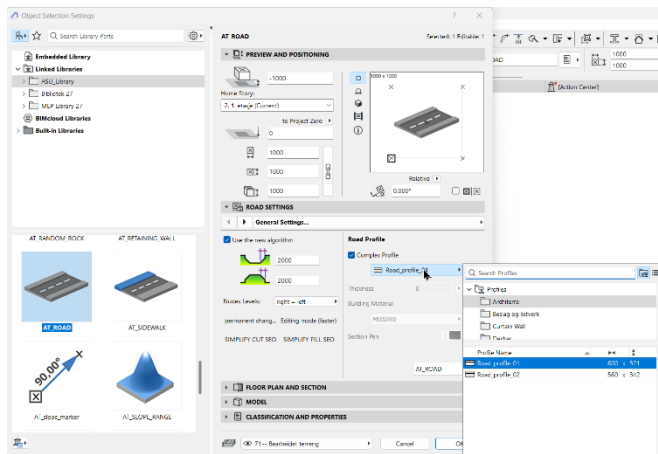

Now click on the Save button on the Profile Manager palette. The necessary composite is created and can be applied for Road.

Now select the road and open the settings window. Turn on the Complex profile checkbox and select the composite from the list. Click on OK, and it will immediately applied on the selected road.

If you make a Section through the road, you can see that the road has already the composite structure.

Some earlier settings are moved from first TAB to the next one, like:

- Shoulder for both side of the road with size and material
- Road line
- Curb on side

In this settings window is possible to switch on/off the visualization of road line, set the colour of it. Also, possible to switch on/off the curb on all sides, set the size, shape and the material of it.

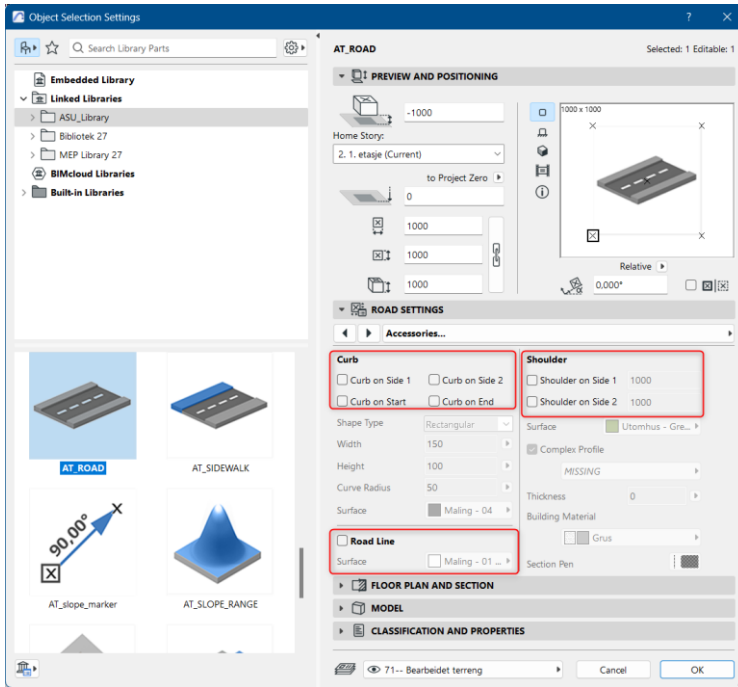

The road line and the curb is visible in 2D and 3D.

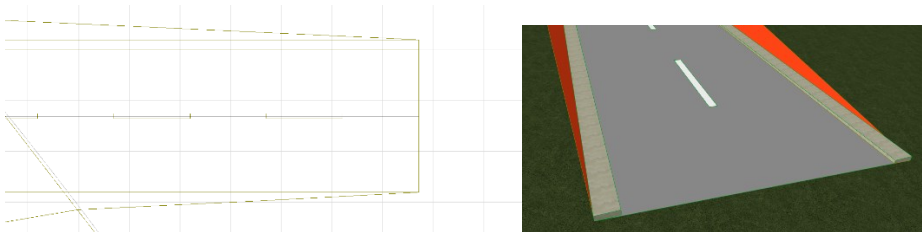

Creating a road using an ARCHICAD fill as described above, by using a polyline the user will obtain a “regular” shaped road only (although by dragging the editable nodes subsequently, it can modify the morphology).

Creating a road using an ArchiTerraPlus fill

Sometimes is required to create more complex shapes, not necessarily “symmetric” on the two sides. In this case, users can use an ARCHICAD fill to define the shape of the element more freely. Using the ARCHICAD Fill tool, draw a polyline to represent the edge of the road:

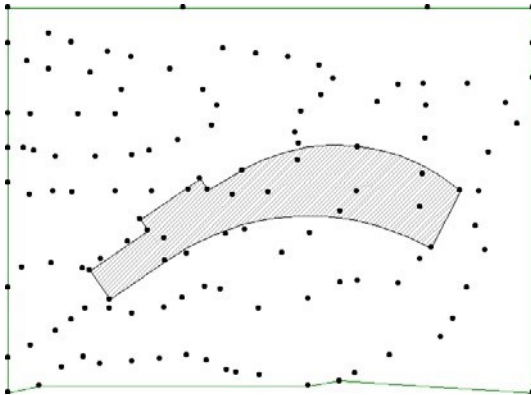

NOTE:

The nodes of the polyline are extremely important as they define the variations in altitude of the element. ArchiTerraPlus uses these nodes to calculate the altitude of the element which will be placed on the ground with those coordinates (from the side selected as the reference side).

Select the fill and click on the Road tool in the ArchiTerraPlus toolbox to display the *Road settings dialog box* (where the road width field will be disabled). From this point, the procedure is the same as described in the previous topic.

Configure the settings as required and confirm by closing the dialog box by clicking OK. ArchiTerraPlus closes the dialog box and the cursor changes shape, waiting the user to make two clicks to define information fundamental to creating the element. The first two clicks must be performed on the two sides which identify the two ends of the road.

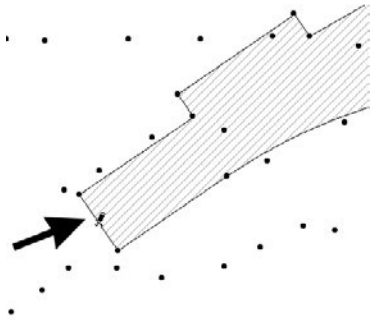

Click to define the starting side

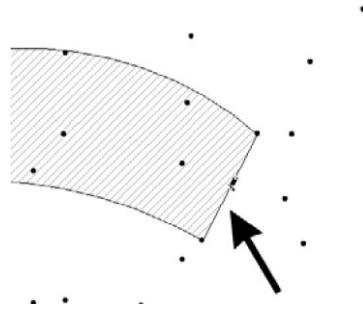

Click to define the end side

After the second click, the operation is calculated and displayed on the terrain:

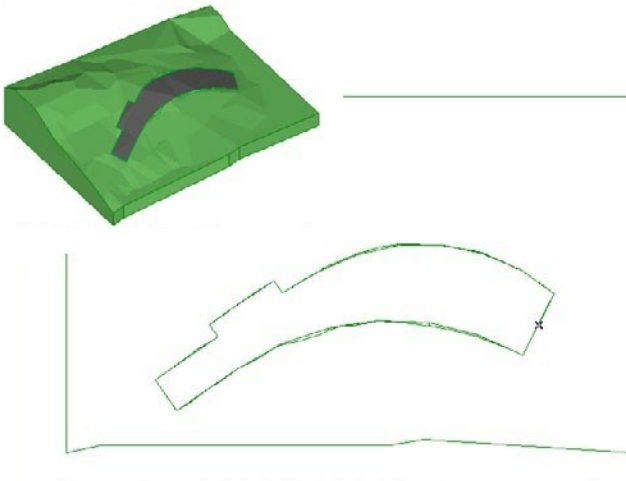

New functions presented above are also working in case of this type of Road.

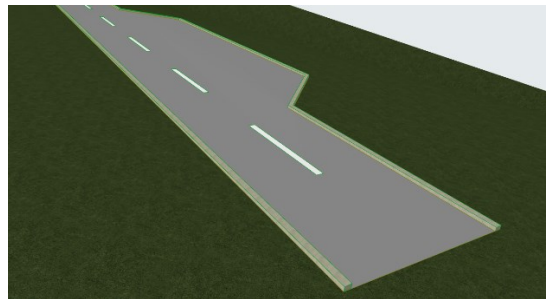
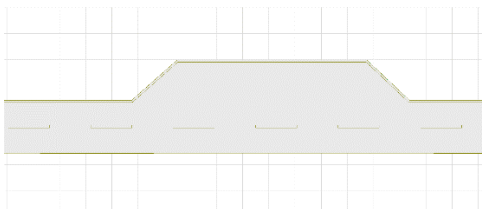

Modifying roads

As already mentioned, these operations are parametric and can therefore be modified at any moment.

1. In the map view (or the 3D view) by clicking on one of the perimeter nodes.
2. Click on the nodes, drag them, and release them in the required position as it would be to modify any ARCHICAD polygonal element (slabs, fills, etc).
3. After modification, click on the *Data Update tool* to update the preview of the element in the map view.



Selecting the operation

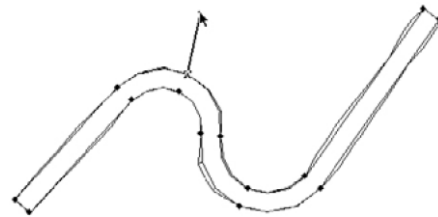

Moving the nodes



Updating the preview in the map view



The element parameters can be modified in exactly the same way as any ARCHICAD library element:

1. In the map view (or the 3D view) by clicking on one of the perimeter nodes.
2. Click on the icon of the relative tool in the ArchiTerraPlus toolbox to display the settings dialog box.
3. Carry out the necessary modifications.
4. Confirm the modifications by closing the dialog box with the OK button.

Creating road junctions

As seen in the previous topics, each node on the side of the road can be dragged into the required position. In addition, the road itself can assume any shape and therefore by dragging and positioning the nodes it can obtain any type of road junction.

Creating a junction with additional nodes

Imagine a situation in which the user wants to create the following junction on a terrain:

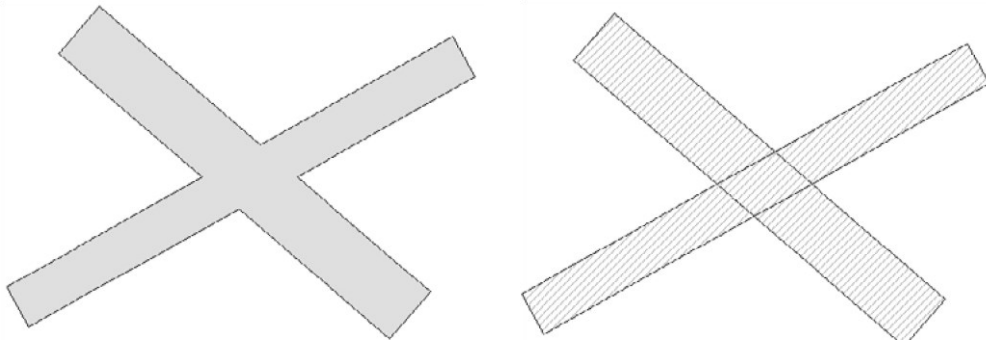

Draw two fills to represent the roads and in each of the two fills, add four nodes at the junction with the other fill/road:

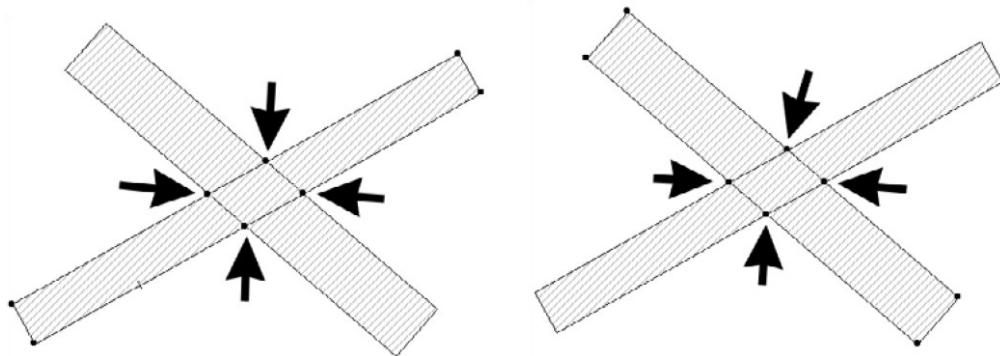

At the junction, each of the two roads will now have editable nodes that can be used to adjust their shape.

Now, following the usual procedure, the two roads can be generated.

1. Select the fill representing the first road and click on the Road tool.
2. Configure the parameters in the *Road settings dialog box* and confirm the modifications with the OK button.
3. Now, in the map view, make the two clicks required to define the start side and end side of the road. ArchiTerraPlus will now generate the first road.

Before going on to create the second road, configure the altitudes of the perimeter nodes of the road just created to achieve the required result.

This operation **MUST** be performed before generating the second road. In this way, the nodes on the junction will already be at the correct altitudes and the second road corresponding to the junction will already be configured correctly. Repeat the above procedure with the second road. Creating a junction with a road/junction.

We believe that the junction creation procedure suggested in the following example is simpler, more flexible, and more immediate than many other methods, although the method described above enables you to manage the angles of the side slopes of the roads at the junction precisely and is therefore preferable.

The following image shows a terrain/mesh and two roads which cross at the centre:

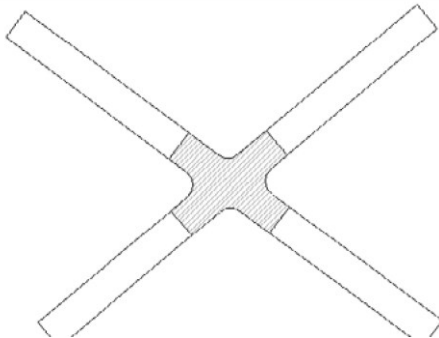

The junction, represented by a fill with 45° hatching, also contains curved parts. As explained in previous paragraphs, there are in fact no limitations to the shape.

The four roads have also been represented using fills.

We will now process these roads.

1. Select the road at the bottom left together with the terrain/mesh and click on the Road tool.
2. Configure the settings dialog box and confirm the modifications by clicking on the OK button, then make the two clicks required as described in the previous paragraph.

Repeat the same procedure with the other three roads. The result will be similar to the following:

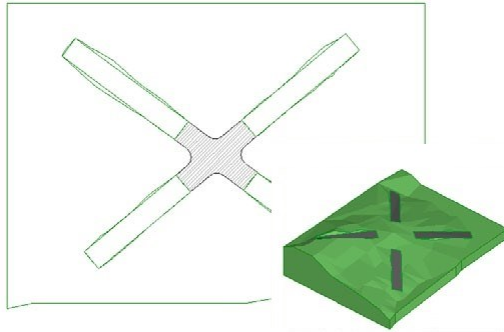

Before created a junction, make all the necessary modifications to the altitudes of the road levels until obtain the desired situation (thus avoiding the need to manually reconfigure the altitudes of the junction nodes during subsequent phases).

Now select the fill which represents the junction and repeat the same procedure, in other words, the junction is considered as if it were a road.

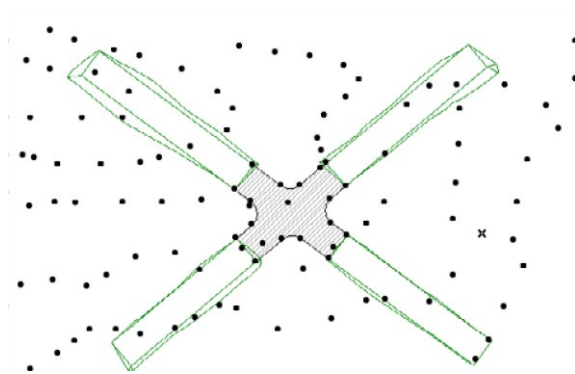

Click on two sides to define the ends of the road/junction:

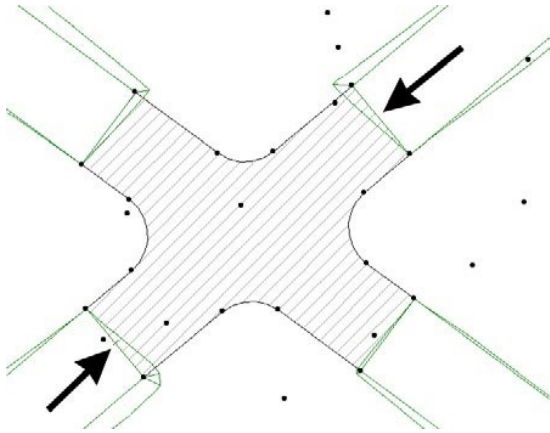

And ArchiTerraPlus immediately calculates the road/junction:

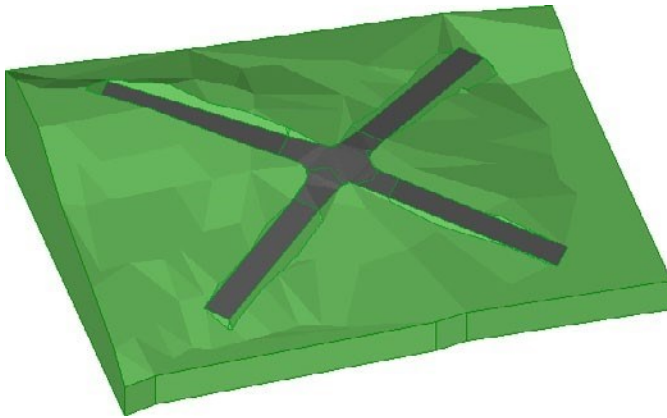

Road longitudinal section tool

As will be described below, the nodes of the road can either be dragged along the X-Y plane or along the Z-axis and the levels of the road can therefore be modified graphically without having to use Longitudinal Sections.

This procedure may be, however, still useful as it is an excellent tool for documenting the longitudinal section of the road.

IMPORTANT:

Looking forward for a future version which will also include cross-sections, we suggest to use only one longitudinal section. As far as in most cases the cross-section are horizontal, it should not be a problem. Where still two longitudinal sections are requested, we suggest using the older dialog.

To create a longitudinal section of the road follow the steps below:

1. In the map view, select the road whose longitudinal section is preferable to see and click on the Longitudinal Section tool in the ArchiTerraPlus toolbox. ArchiTerraPlus immediately displays the tool settings dialog box:



2. Configure the settings as required (they will be explained in more detail below) and confirm by clicking OK.

3. ArchiTerraPlus has already selected and appropriately configured the AT3_ROAD object. By clicking in the map view or, preferably, open and click in the Section/Elevation view it can be defined the insertion point for the longitudinal section object and the section which will be inserted in the worksheet as requested:

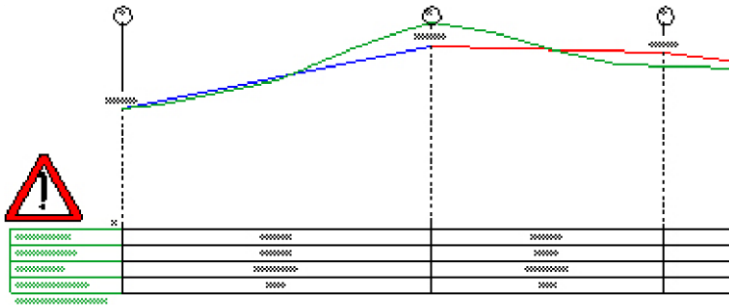

Data requires updating

This object is intimately linked to the Road object on the map. All modifications (mainly to the altitudes) can be automatically transferred to the original Road object by selecting the modified section object and clicking on the Data Update tool icon.

Whenever the section object is modified, remember to update at the end of the procedure using the Data Update tool (which transfers the modifications to the road on your terrain). It will be seen a warning icon which will disappear as soon as the update has been performed:

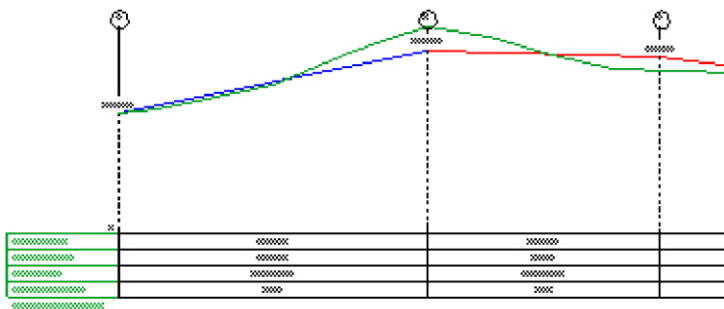

Data already updated

Configuring Longitudinal Section Settings



The numerical field at the top left enables to set the reference altitudes (within the limits of the interval available). The user can use this field, for example, to align the various longitudinal sections and make them congruent.

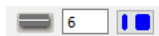

Pen for straight sections of the road.

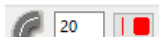

Pen for curved sections of the road.

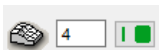

Pen for the terrain profile.

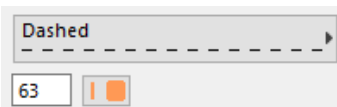

Line type and pen for vertical reference lines.

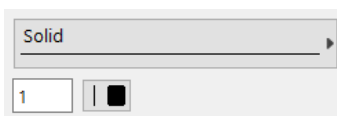

Line type and pen for table grid lines.

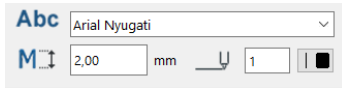

Font, character size and pen for text.

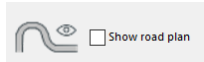

Check-box to show/hide the plan of the road. It may be useful to display the plan when the longitudinal section has been inserted in an ARCHICAD Section/Elevation view. The plan may be a useful reference when making modifications.

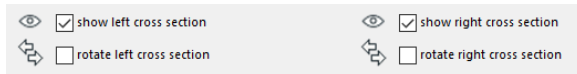

This check-box allows to reverse the direction of the profile. The original direction of the two profiles derives

from the direction of the road itself (calculated from the 2D elements - polylines or fills - used to generate it).

These controls allow users to manage the orientation of the road as you wish. Finally, the last pop-up menu allows users to choose the layer for the longitudinal section.

Modifying road levels using the longitudinal section

When the user select the longitudinal section, it will be able to see that each node of the road profile corresponds to an editable hotspot:

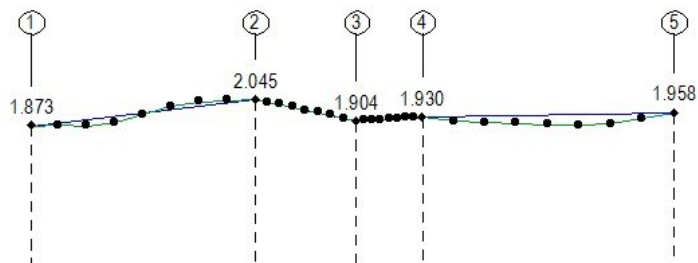

IMPORTANT:

The editable hotspots (displayed by ARCHICAD as small diamonds and in a different colour according to the settings and version of ARCHICAD you are using) correspond to numbered dots at each node along the side of your road.

The other hotspots (simple dots) are merely reference points indicating the original profile of the terrain (and therefore its altitude) along the side of the road.

It is extremely simple to modify the levels of the side of the road, (obviously dragging is automatically constrained to a vertical direction):

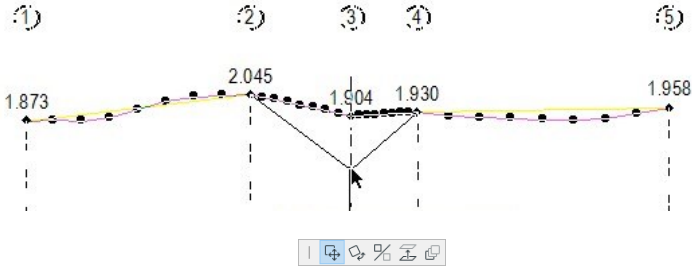

Dragging the node

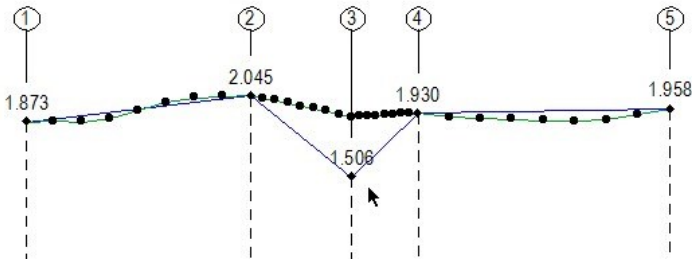

Node dragged into a new position

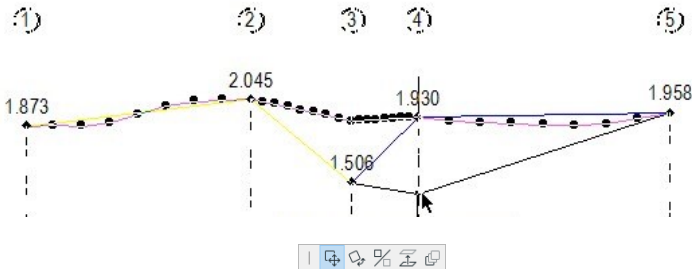

Dragging the node

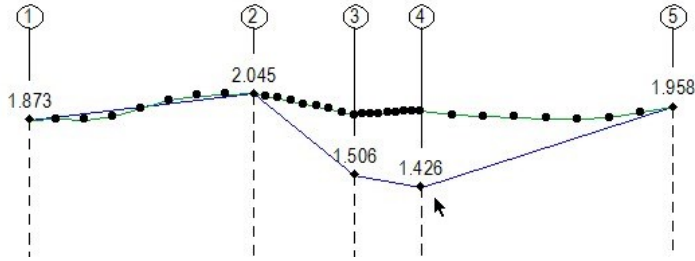

Node dragged into a new position

After modifications, the original road can be updated by clicking on the Data Update icon.

NOTE:

If you are working in Section/Elevation view, the ArchiTerraPlus toolbox will automatically be configured to show only the functions available in this view (namely, the Longitudinal Section tool which enables you to modify the parameters of the elements and the Data Update tool to update the original road).

Railway and Railway crossing

There are two ways to create a road: Using an ArchiTerraPlus polyline or an ArchiTerraPlus fill.

Creating a railway using an ArchiTerraPlus polyline

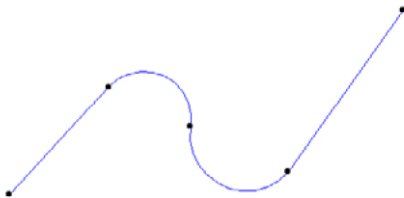

Using the *ArchiTerraPlus Polyline tool*, draw a polyline to create the centre line of the railway to be created.

NOTE:

The nodes of the polyline are extremely important as they define the variations in altitude of the element. ArchiTerraPlus uses these nodes to calculate the altitude of the element which will be rested on the ground with these coordinates.

Select the polyline and click on the Railway tool in the ArchiTerraPlus toolbox to display the *Railway settings dialog box*.

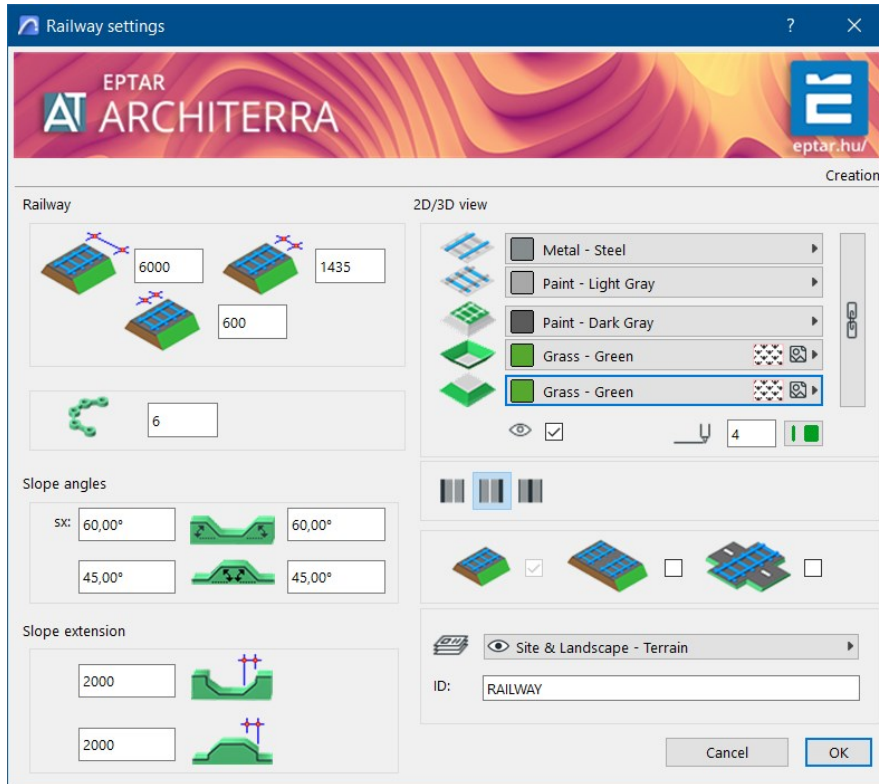

The first value in the Railway section indicates the width of the railway. Use a polyline to create Railway with a constant width.

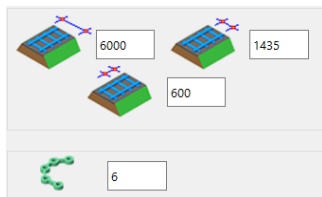

Immediately below in the Slope Angles section, four fields allows to define the angle of the excavated and filled scarps on the right and left of the railway.

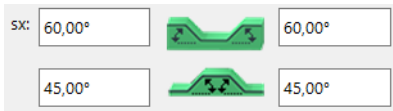

Below this, in the Slope extension section, it can be defined a value for the length of the scarps. These two values follow the same logic and have the function as described previously for the Plateau tool.

At the top right in the 3D Model section, the user can configure the resolution of the curved parts and the three materials used for the surface of the road and the surface of the excavated and filled scarps (the chain on the right enables the same material to be assigned to the three surfaces).

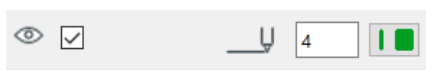

In the 2D/3D View section, it can be configured whether the perimeter of the railway will be displayed in the map view (by activating the relative check-box on the left) and the pens used to represent the edge of the railway in the map and 3D views.

If the railway crosses the road, the special object helps to create the correct railway crossing. For first step you need to place 2 (two) railways (on both side of the road), set the required height of the railway ends. After it draw the polyline between two railways and select it, then click on Railway Tool. In the settings window set the checkbox for



railway crossing and click on OK button. The program will place the necessary railway crossing element. After it the railway ends can be adjusted to it's high.

The ID field in the Listing Attributes section can be used to assign an identification string to the element in order to recognize it in the project lists to calculate the volumes of earth moved. Lastly, the pop-up menu at the bottom right allows to define the layer where the element object is stored.

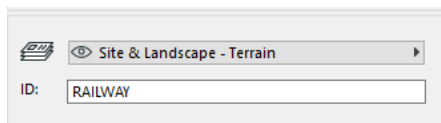

Confirm the modifications made to the settings using the OK button and ArchiTerraPlus will immediately process the railway as requested.

After the railway is placed there are some settings available in the Railway objects settings window. Select the Railway object, and open an Object Settings window.

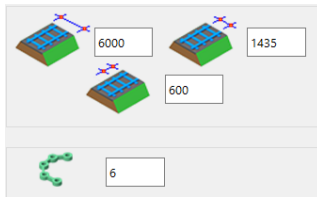

If the main parameters should be changed, select the railway object and open the ArchiTerra Railway settings window, the set necessary values.

Ditch tool

The ditch is a quite important part of the terrain project. The is working with similar method as all other Architerra tools: place the track line and generate the element. In case of ditch there are two different ways to create it depending on its location, position.

The dich next to road:

- place the track line on the edge of road element with polyline tool, then select it with the road together.

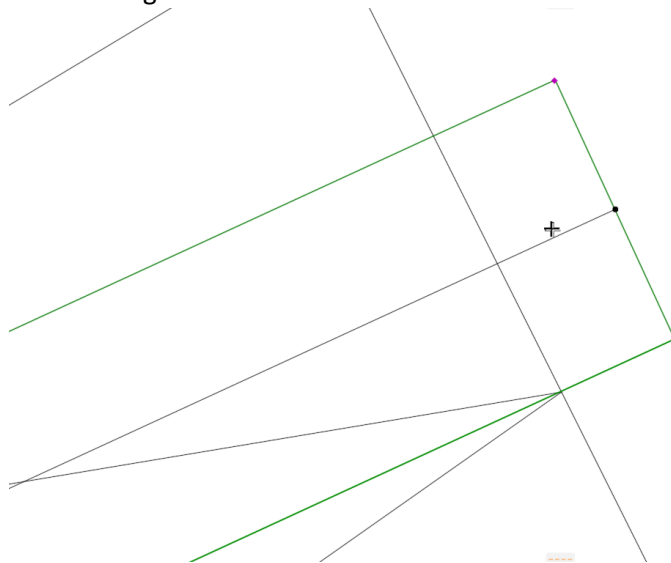

- click on the Ditch tool icon in the Architerra palette.

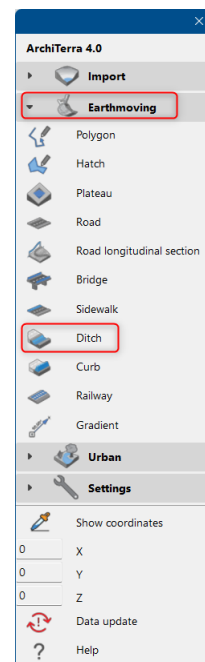

- the settings window appears, and there are many parameters: first is the position of the ditch. If the “Attached to the road” is set, the add-on will adjust ditch’s points to the road edge and to the road height. There is a “Road distance” parameter, which is a distance between road edge and ditch edge, if necessary. On the right side we can select the ditch type: simple ditch, when there is only a ditch dug, and the second is with lining. Below there is a slope parameter, the size of the ditch, and the “Profile from Profile Manager”, where we can create a really special profile for ditch.

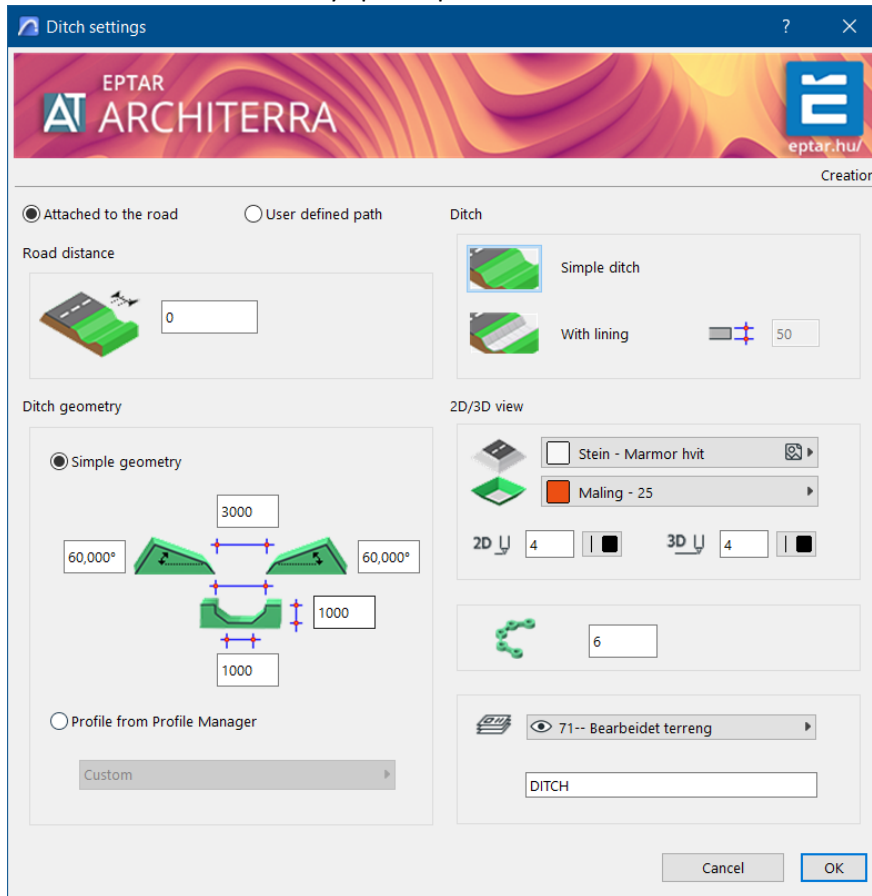

- Clicking on OK, the add-on places the ditch next to the road as well. The ditch is selectable, and we can modify its point to the right or necessary position.

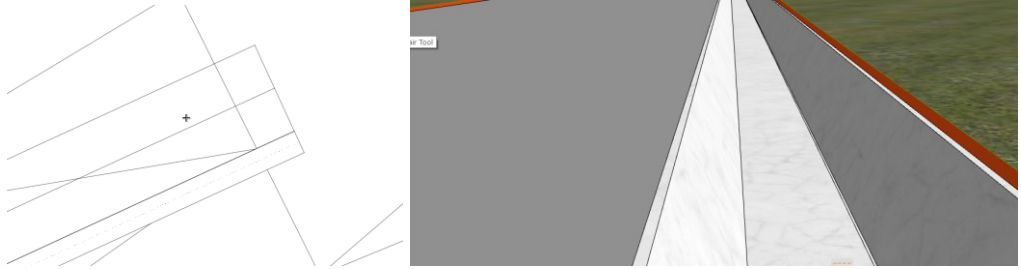

The standalone ditch on independent track line:

- place the track line to the necessary position and select it.
- open the settings windows and it's already visible, that in this case there is no option allowed, the "User define path" is selected, and the setting is inactive.
- all other parameters and profile settings are active and possible to set.
- click on OK the ditch is placed.

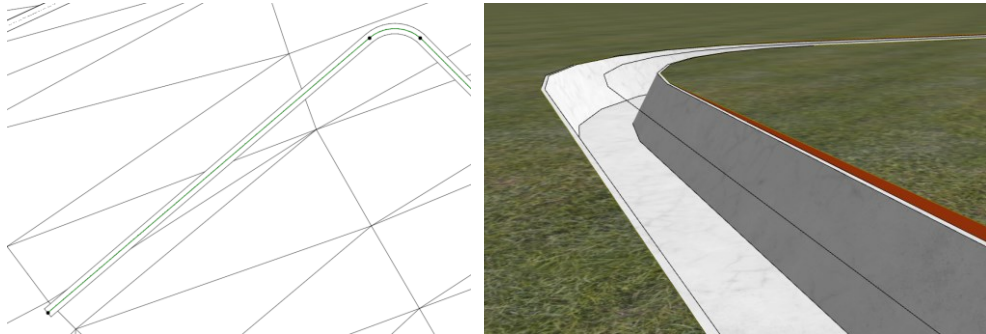

Custom profile for ditch:

- in the settings window there is an option to use custom profile, which we create with Profile Manager.
- first open the Profile Manager and create the custom profile for Objects

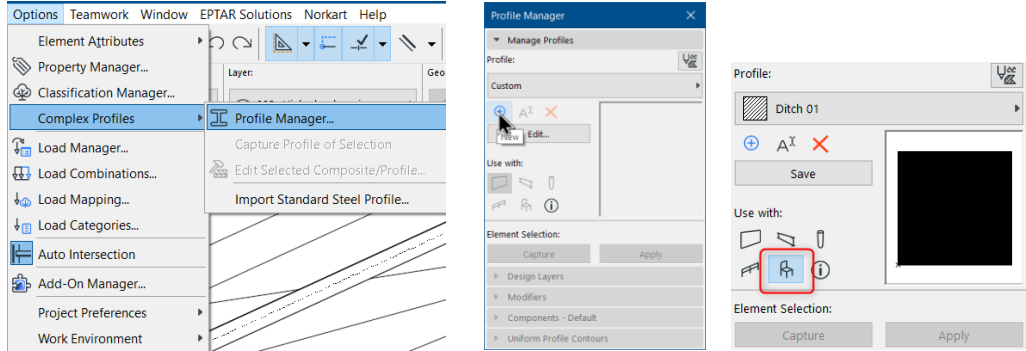

- place the track line (path), select it and open the settings window
- on the bottom side of the window there is an option to select "Profile from Profile Manager" checkbox. Selecting it the profile list created with Profile Manager – is available and it's possible to choose the required one.

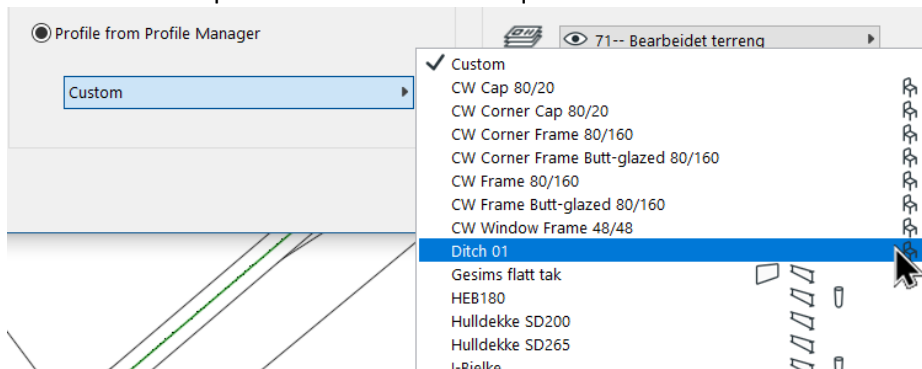

- Select it and click on OK, and the ditch is placed with the selected custom profile.

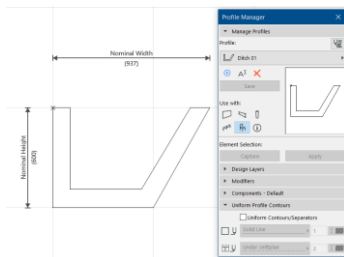

Curb tool

Up until now in ArchiTerraPlus this function was available in the Road element, and it was directly connected to it. This is still available in the Road object, but to create a correct curb at the necessary place, we implemented a standalone tool for it. The advantage of this tool that we can define a curb at any place with the length what is not depending on the predefined road length. Second advantage, that there is possibility to use custom profile for it, which profile is possible to do with “Profile Manager” of Archicad.

Creating a standard curb:

- draw the path with the polyline on the edge of placed road, select the road and this path, and open the Curb Settings window

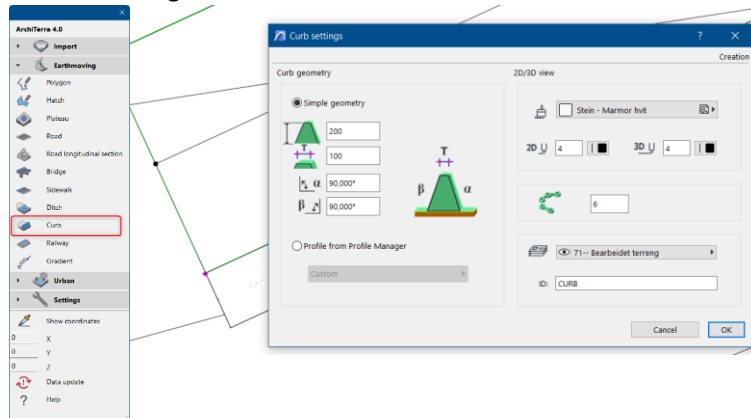

- in the settings window – if we select the “Simple geometry” option - we can configure the size of the curb profile, then click on OK. When the window disappeared, in the end of the path line the small “Arrow” indicates, on which side the curb should be placed.

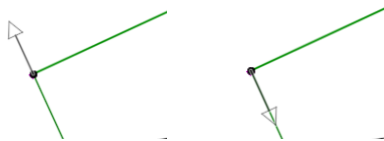

- click on right side and the curb is placed.

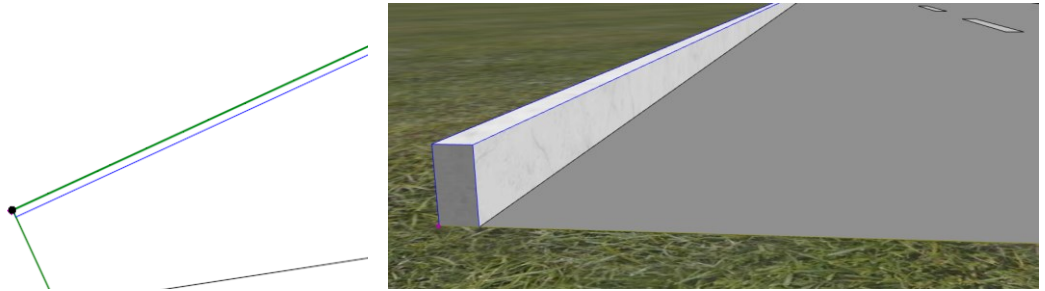

Creating a custom profile curb:

- draw the path with the polyline on the edge of placed road, select the road and this path, and open the Curb Settings window.
- select the “Profile from Profile Manager” option, and choose a custom profile from the list of Profile Manager

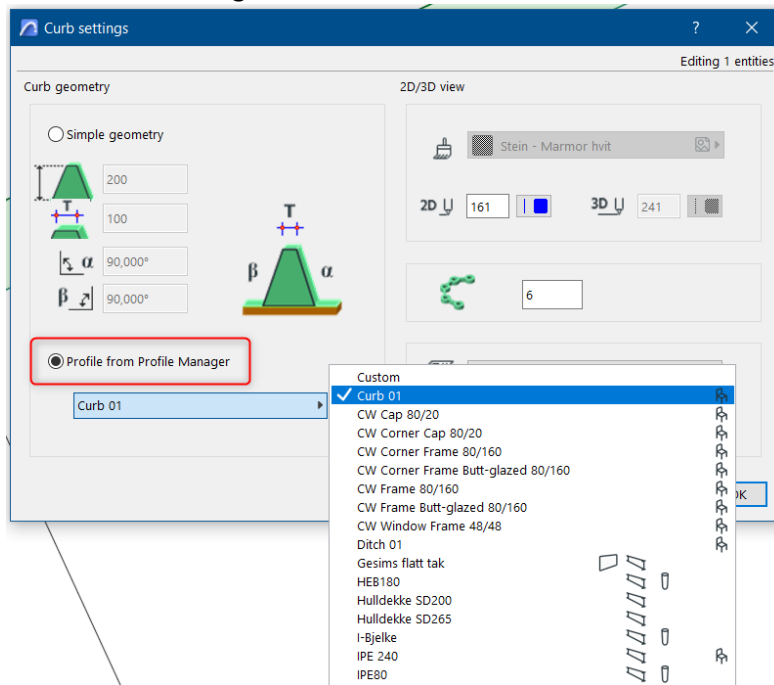

- click on OK, and the selected custom profile is applied.

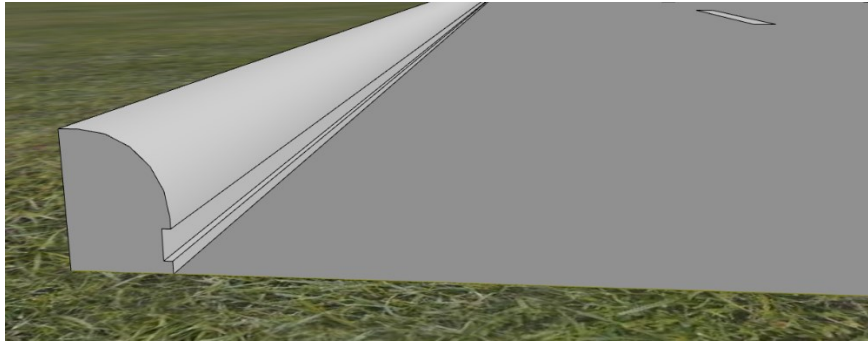

Bridge / Railway Bridge tool

Up until now in ArchiTerraPlus 1.5 this function was available only for Road Bridge. Now as a new option the user can define and create Railway Bridge also. It is possible to place using the similar method and settings window as in case of Road Bridge.

This tool can place a strait Bridge element ONLY, the polyline and curved construction is still not available.

For first step you need to place 2 (two) roads (on both side of the river or valley), set the required height of the road ends. After it draw the polyline between two roads and select it, then click on Bridge Tool. In the settings window you can find an already standard settings of ArchiTerraPlus elements (size, border, 2D/3D representation, etc) and the Raily Bridge settings are also here. In Railway settings part the user can set 1way, 2ways rails and set the global parameters of it:

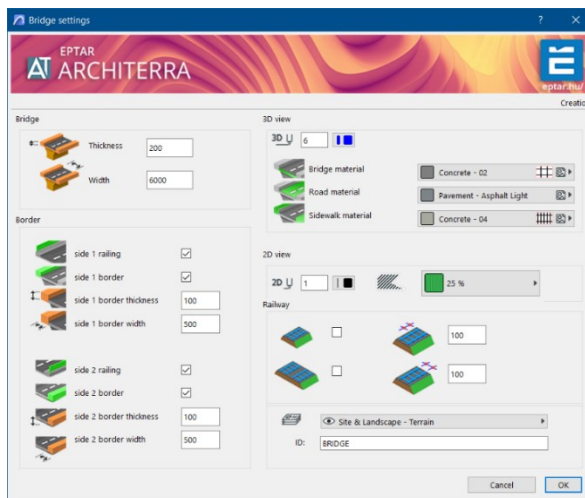

After setting of required parameters click on OK and the program will place a bridge element on the predefined line between two road ends on the level of roads. After the bridge is placed, you can set many other parameters and functions in the ARCHICAD Object Settings window. Select the bridge element and open a setting window:

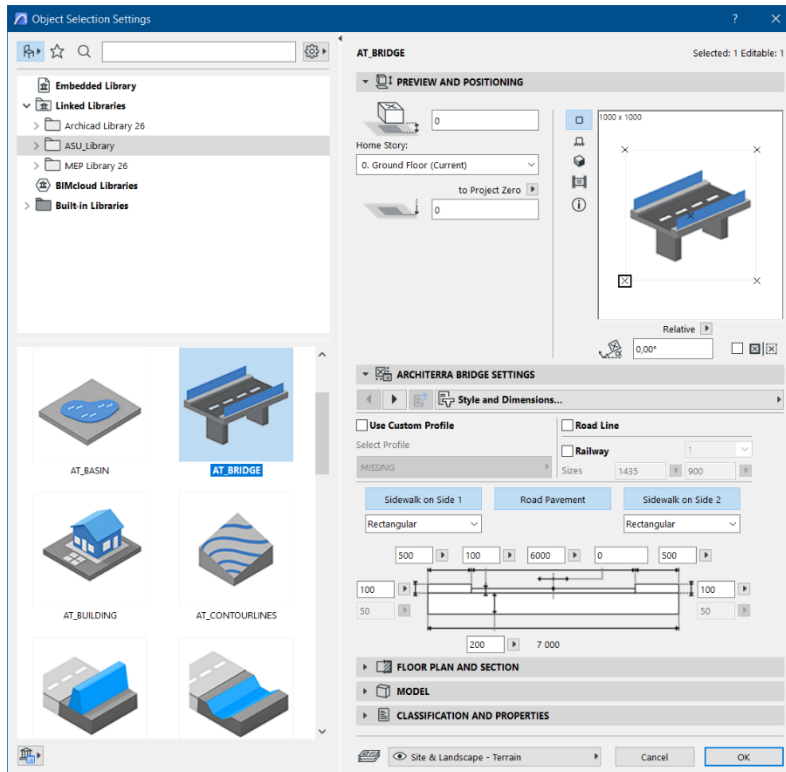

On the first tab you can switch on/off the road line and set the custom profile for the bridge deck, even for Railway bridge. The default profile is a simple slab, no in this case you can define the sidewalk on both side and the pavement.

Custom profile: to create a custom profile you should use a default ARCHICAD Profile Editor. Open an ARCHICAD menu-Options-Complex Profiles-Profile Manager and create any profile, any shape what you would like to use for Bridge. Please note, you should define the deck, the sidewalk, and the pavement of the bridge. Do not forget to apply this profile for ARCHICAD Object!

In case of custom profile, the sidewalk and the pavement should be defined in Profile Editor of ARCHICAD.

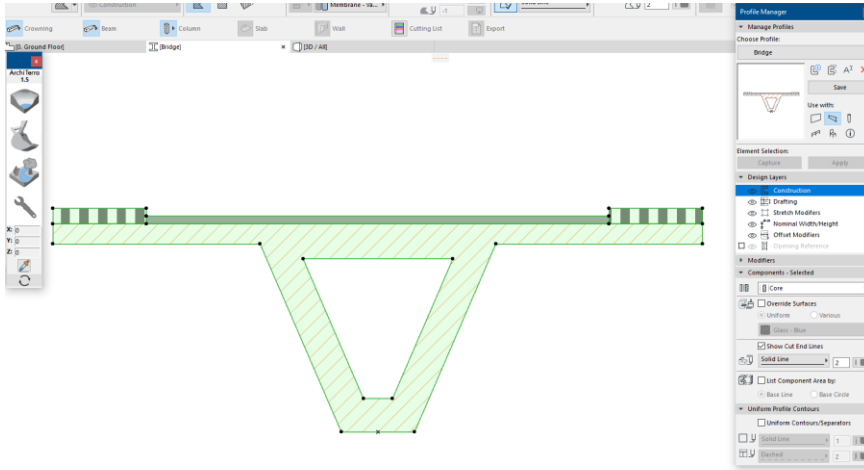

Saving this profile, you will be able to use it in case of Bridge:

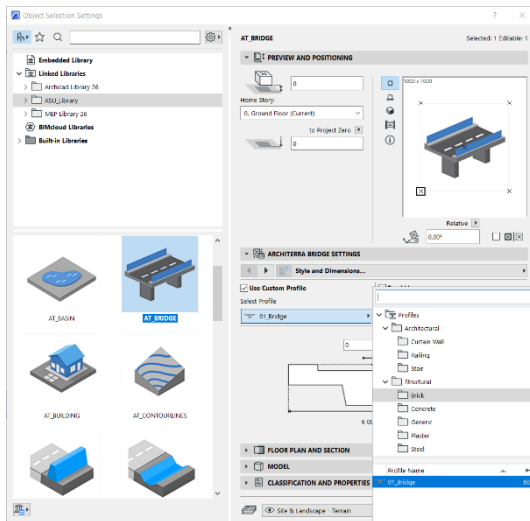

When you select a Custom profile the width of the bridge, the sidewalk and the pavement will be the size what you defined in the Profile Manager. If you would like to change these sizes, you should edit the profile in the Profile Manager and save it.

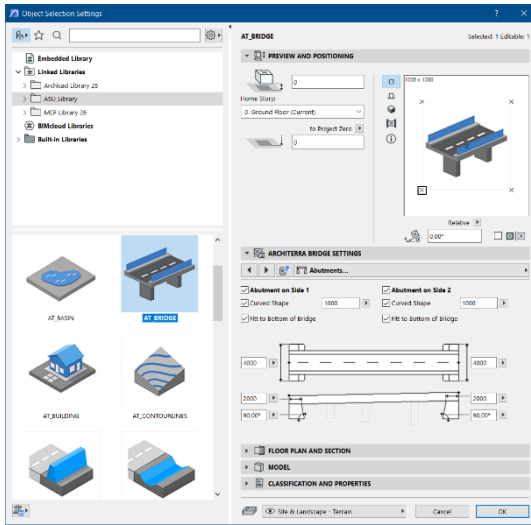

On the next TAB of the Bridge settings window, you are able to switch the Abutment on both ends of the Bridge. The size, the shape of the abutment (curved or rectangular), and the Inclined Angle of it can be set. You can also decide how the abutment connected to the deck of the bridge: fit to bottom of bridge or not.

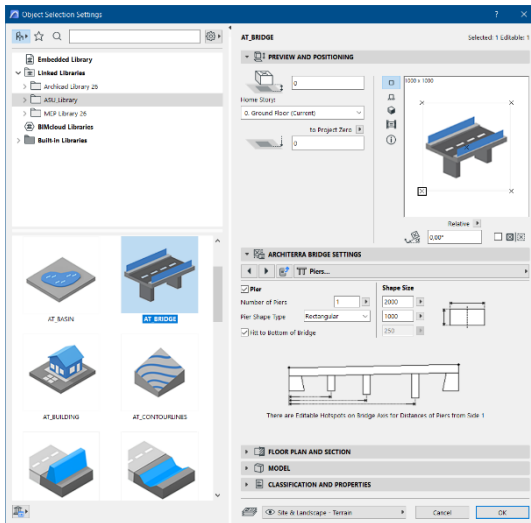

On the 3rd tab of the Bridge settings window, you can apply Piers, if the Bridge is too long. The size, the shape of the Pier (Rectangular, Curved rectangular, Oblong, and Circular), and the amount of them can be set. You can also decide how the pier connected to the deck of the bridge: fit to bottom of bridge or not.

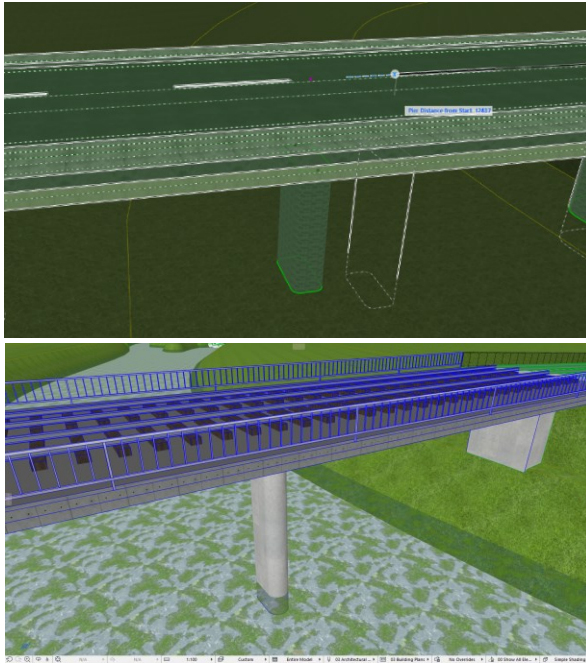

The position of the Piers is modifiable graphically with hotspots in 2D and 3D.

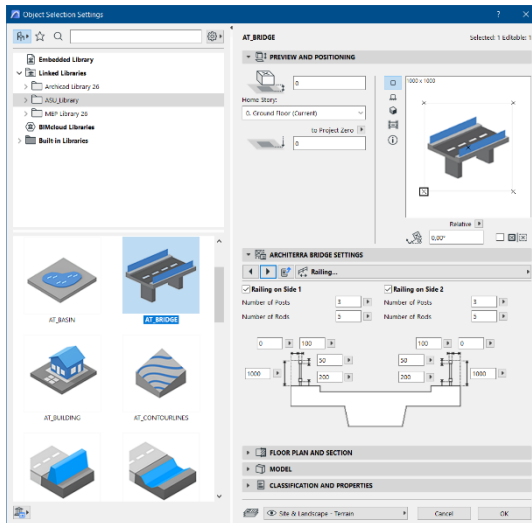

On the 4th tab of the Bridge settings the Railing can be set on both sides with size, position parameters. You can set the number of Posts and Rods separately, set the size of them.

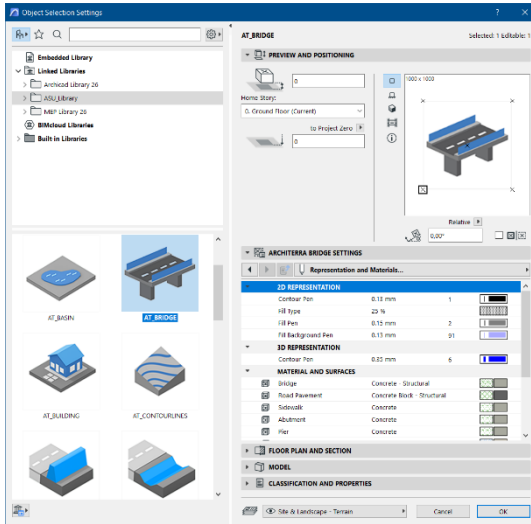

On the 5th tab of the Bridge settings, you can set all 2D and 3D representations parameters.

Pavement, Sidewalk tool

To create Pavements or Sidewalks users can use ArchiTerraPlus fill to define the shape of the elements more freely.

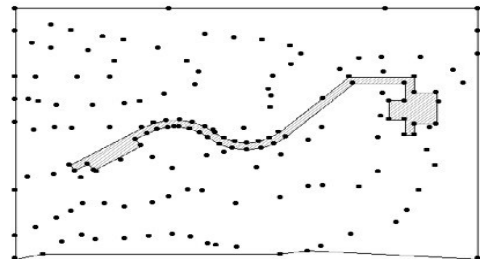
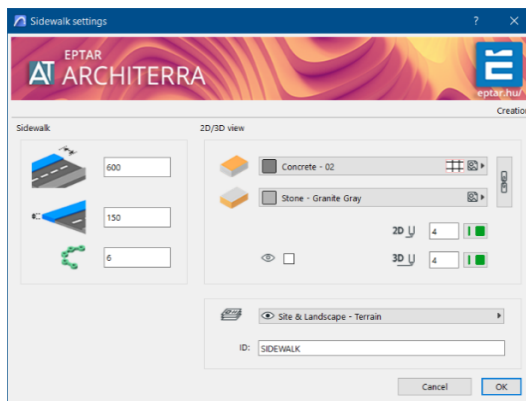

NOTE:

The nodes of the polyline are extremely important as they define the variations in altitude of the element. ArchiTerraPlus uses these nodes to calculate the altitude of the element which will be placed on the ground with those coordinates (from the side selected as the reference side).

Select the fill and the terrain/mesh and click on the Pavement tool in the ArchiTerraPlus toolbox to display the *Pavement settings dialog box*.

From this point, the procedure is the same as described in the above paragraph. Configure the settings as required and confirm by closing the dialog box by clicking OK.

ArchiTerraPlus is waiting for the user to make two clicks to define information fundamental to creating the element.

The first two clicks must be performed on the two sides which identify the two ends of the pavement.

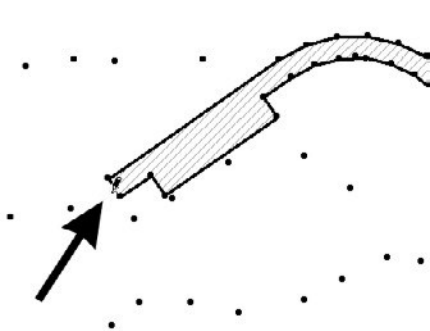

Click to define the starting side

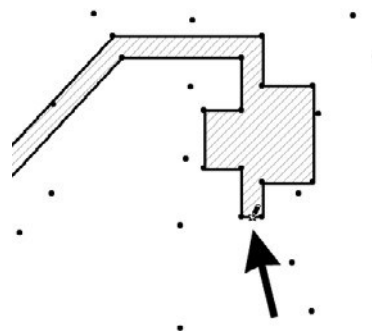

Click to define the end side

Note:

The fill must be designed completely on a Road or on a Plateau.

Modifying pavements

The shape can be modified extremely easily:

1. In the map view (or the 3D view) by clicking on one of the perimeter nodes.
2. Click on the nodes, drag them and release them in the required position as it would be to modify any ARCHICAD polygonal element (slabs, fills, etc).
3. After modification, click on the Data Update tool to update the preview of the element in the map view.

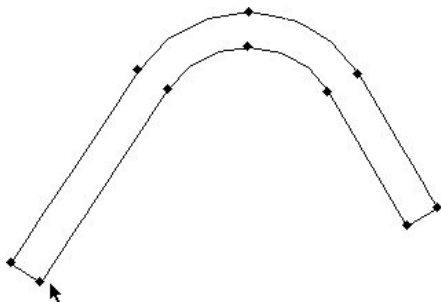

Selecting the element

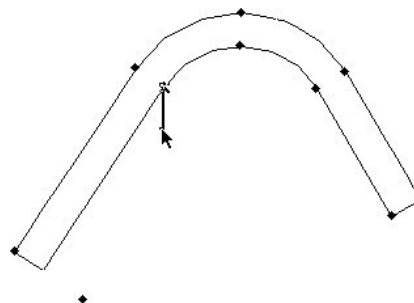
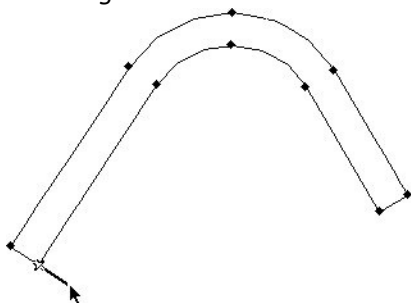

Moving the nodes

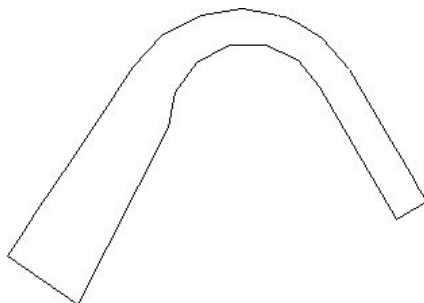

Updating the preview in the map view

Gradient tool

The Gradient tool is a new tool. With this tool is possible to determine the slope value between 2 points of the terrain. The result of slope the tool can indicate on the floor plan in percentage and in degree, which can be set in the setting window of the tool.

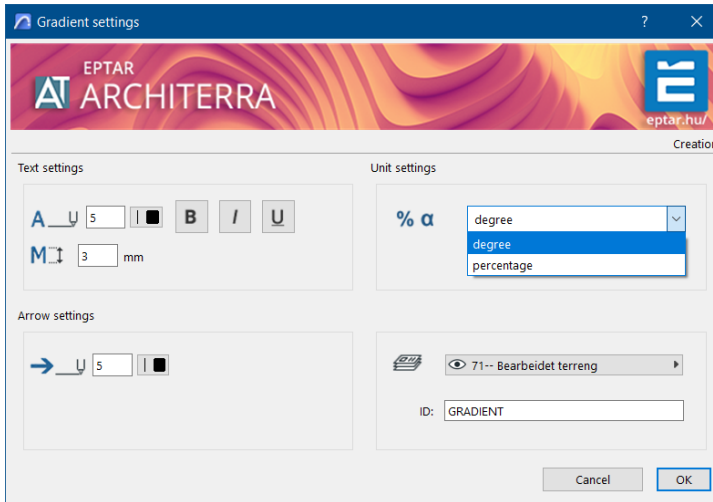

Process of work:

- select the Gradient tool, then click on first point (it's a start point), and after click on second point.

The add-on will calculate the slope and place the Arrow with the value.

Note: the value is calculated between two selected point, but these points are selected too far from each other, and between them different highs are, the value can be not a real slope value.

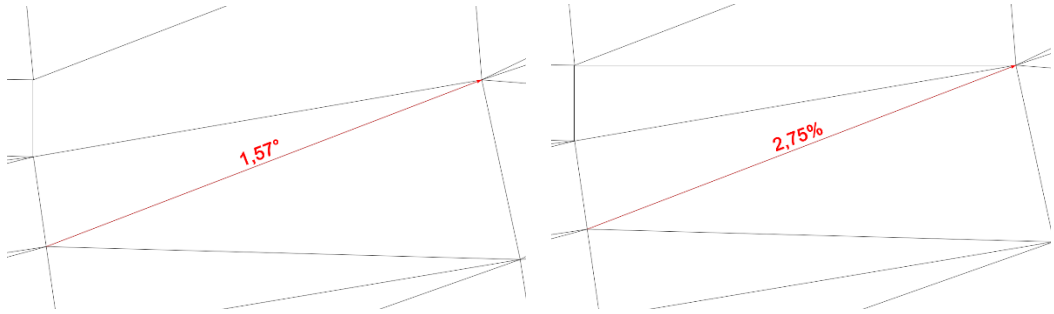

The placed Arrow is possible to modify with Hot spots, and with it's parameters in the Settings window.

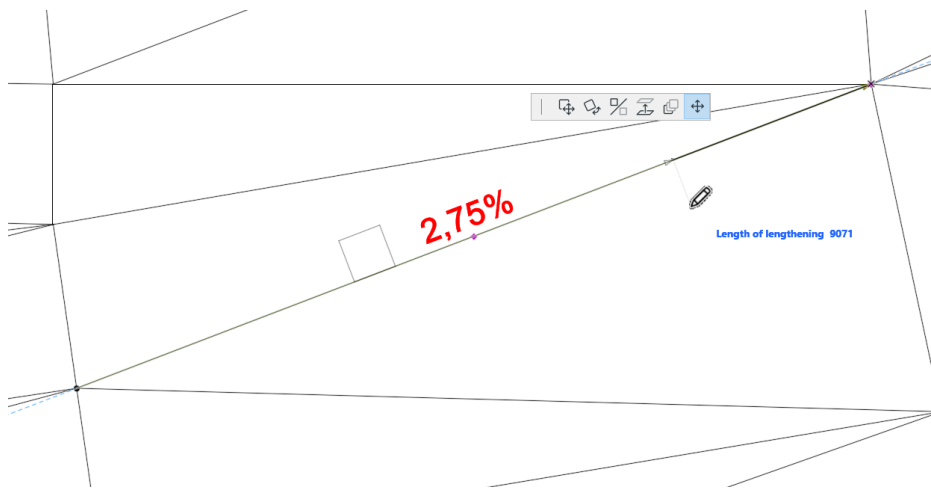

Random tree generation functions

Click on the Random Generation tool and ArchiTerraPlus immediately displays the *Tree settings dialog box*:

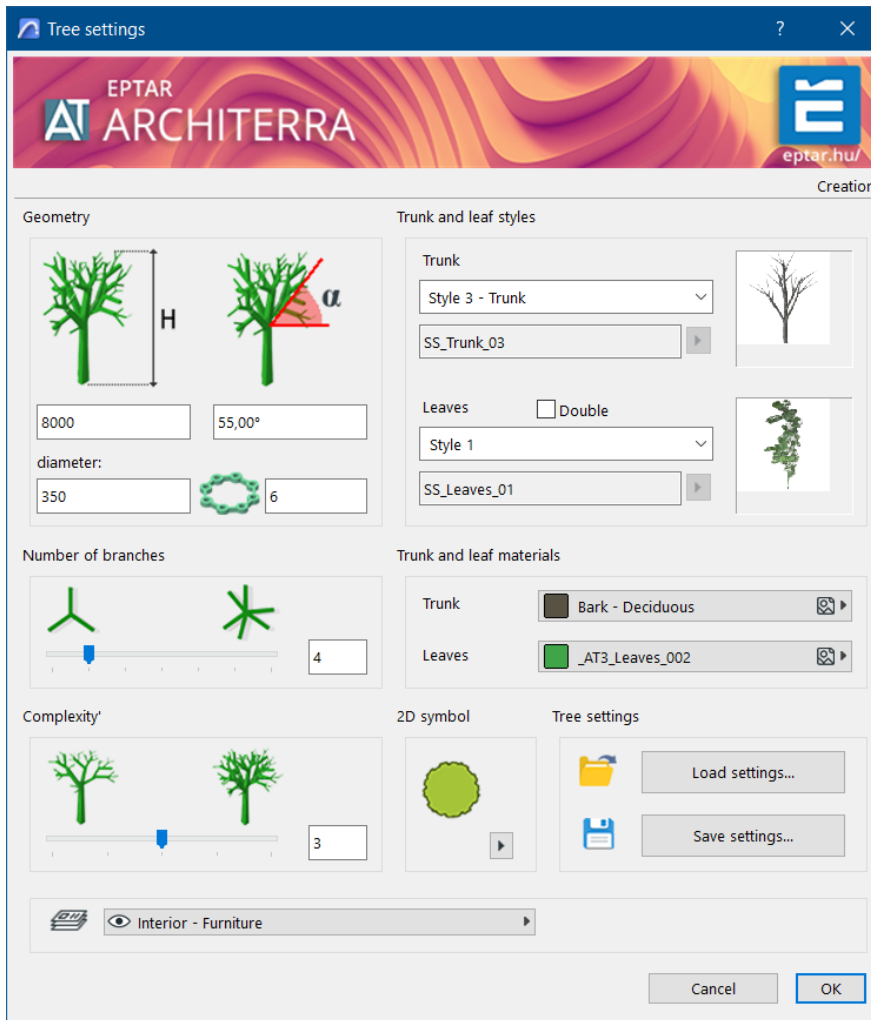

In the Geometry section it can be defined the total altitude of the tree, the angle of the branches with respect to an imaginary horizontal line (the value can be negative to generate conifers), the diameter of the trunk and the resolution used.

In the Number of Branches section, it can be defined the number of branches which start out from the trunk (and then from each subsequent branch). In the Complexity section, the user can define the number of repetitions.

For example, if the user set a Complexity value of 1, it will have a tree with just one series of branches starting out from the trunk.

If the user set a Complexity value of 2, it will have a tree with one series of branches starting out from the trunk, then another series of branches starting out from each of the previous branches.

IMPORTANT:

Obviously the higher the values used, the more realistic and effective the result, but at the same time the more complex the calculation. Aim for a good compromise to have trees which are quick to calculate, but sufficiently realistic.

In the Trunk and Leaf Style section, you can customize the resulting tree. The first popup menu allows users to choose between four possible trunk styles:

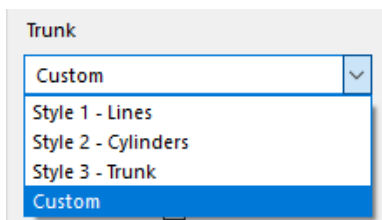

Style 1 Lines: Trunk and branches are simple lines.

Style 2 Cylinders: Trunk and branches are simple cylinders (with the resolution set in the Shape section).

Style 3 Trunk: Trunk and branches have a realistic appearance which simulates the natural shape of these elements.

Custom: This enables the user to use a previously defined library element to represent the trunk and the branches (see the appendix for a description of how to customize these elements).

When users choose Custom style, the small button with an arrow shown below will be activated:

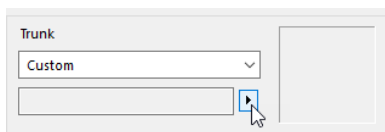

Click on this button to display a dialog box, enabling to select the library element to use to represent the trunk and branches. Once selected the element, the field on the left displays the name of the selected element. The

second pop-up menu allows you to choose between five possible styles of foliage:

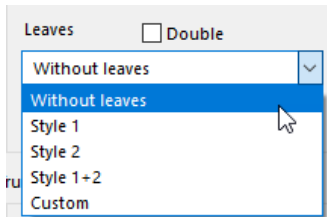

Without leaves: No foliage, only the branches are represented.

Style 1: Groups of leaves with an elongated shape are used.

Style 2: Groups of leaves with a constant shape are used.

Style 1+2: A mixture of groups of leaves with an elongated shape and with a constant shape are used.

Custom: This enables to use a previously defined library element to represent the groups of leaves to be used (see the appendix for a description of how to customize these elements). When chosen Custom style, the small button with an arrow shown below will be activated.

Click on this button to display a dialog box, enabling to select the library element to use to represent the groups of leaves. Once selected the element, the field on the left displays the name of the selected element.

NOTE:

The Double checkbox above the leaf style selection pop-up menu allows the user to double the foliage elements. The tree will be considerably more realistic, but slower to process.

In the Trunk and Leaves Material section, the user can select the material used for these two components of the tree.

The 2D Symbol section allows to manage the method used to display the tree on the map:

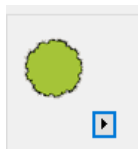

A small preview displays the style currently selected, while the small button at the bottom right opens a dialog to configure the 2D symbol (see detailed description below).

The last section at the bottom right, Tree Settings, is extremely important:

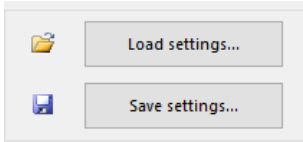

The ArchiTerraPlus random tree generation function is extremely powerful but requires configuration of numerous parameters which can at times become tedious.

What is more, once it has been achieved the required result, the user may want to repeat it in the same project or in other projects without having to configure it again, or without wasting time taking notes enabling you to reconfigure it.

In this case, use the Save Settings... button to save the current configuration which can then be used at any time by using the Load Settings... button.

It will, however, never obtain two completely identical trees. At each insertion, ArchiTerraPlus introduces small variations which make each tree different from all the others. Finally, the pop-up menu at the bottom right allows to choose the layer where the element will be stored.

When the settings are confirmed with the OK button, the procedure to insert the trees in the worksheet begins.

This procedure follows a cycle. After inserting one tree, ArchiTerraPlus waits for the click on the worksheet again to insert another, without having to configure the parameters.

To exit from the cycle, use the standard ARCHICAD procedure (Esc on the keyboard, or Cancel on the Control Bar).

Configuring the 2D tree symbol

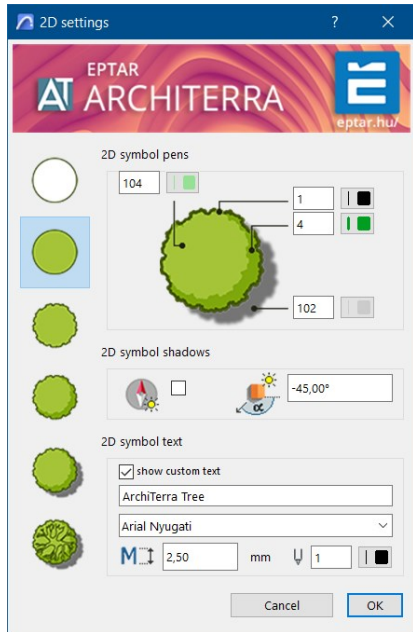

The key panel on the left allows to choose between six styles for the 2D symbol.

The 2D Symbol Pen section can be used to select:

- The pen used for the fill of the foliage.
- The pen used for the outline of the tree.
- The pen used for the shading of the foliage (if the symbol includes shading).
- The pen used for the shadow of the tree (if the symbol includes the shadow).

Below, the 2D Symbol Shadows section allows to manage the shadows in the symbol (if the symbol includes a shadow).

If the first checkbox is activated, the shadow follows the current sun settings configured in the 3D Projection settings dialog box.



The second field is considered only if the check-box on the left is disabled, throwing the shadow at the specified angle.

In the 2D Symbol Text section the user can display text on the symbol (by activating the relevant checkbox). The string displayed is given in the field below (default string:

“ArchiTerraPlus Tree”). The character, size of character and pen used for the text can be configured immediately below.

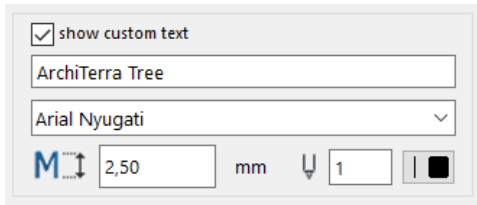

The image shows a dialog box for configuring the ArchiTerraPlus Tree. It features a checked checkbox labeled "show custom text". Below this is a text input field containing "ArchiTerra Tree". Underneath is a dropdown menu showing "Arial Nyugati". At the bottom, there are three controls: a font size selector with a blue 'M' icon and a double-headed arrow, a text input field with "2,50", the unit "mm", a pen style selector with a blue 'U' icon and a double-headed arrow, a text input field with "1", and a color selector with a black square icon.

Changing the parameters of a tree already inserted

As described, ArchiTerraPlus trees are in every way ARCHICAD library elements.

To change the parameters of a tree already inserted:

1. Select the tree or trees in the map view.
2. Click on the Random Generation tool.
3. ArchiTerraPlus automatically displays the *Tree settings dialog box* where it can be made the required modifications.
4. Confirm with the OK button.

Basin tool

ArchiTerraPlus allows to “fill” the terrain by generating a plane at the user defined altitude, modelled according to the land morphology.

The principle is simple. The user indicate the altitude of this plane by clicking on the terrain and ArchiTerraPlus automatically calculates its perimeter.

In the Basin section, it can be configured the pen for the 3D display of the basin and its surface material.

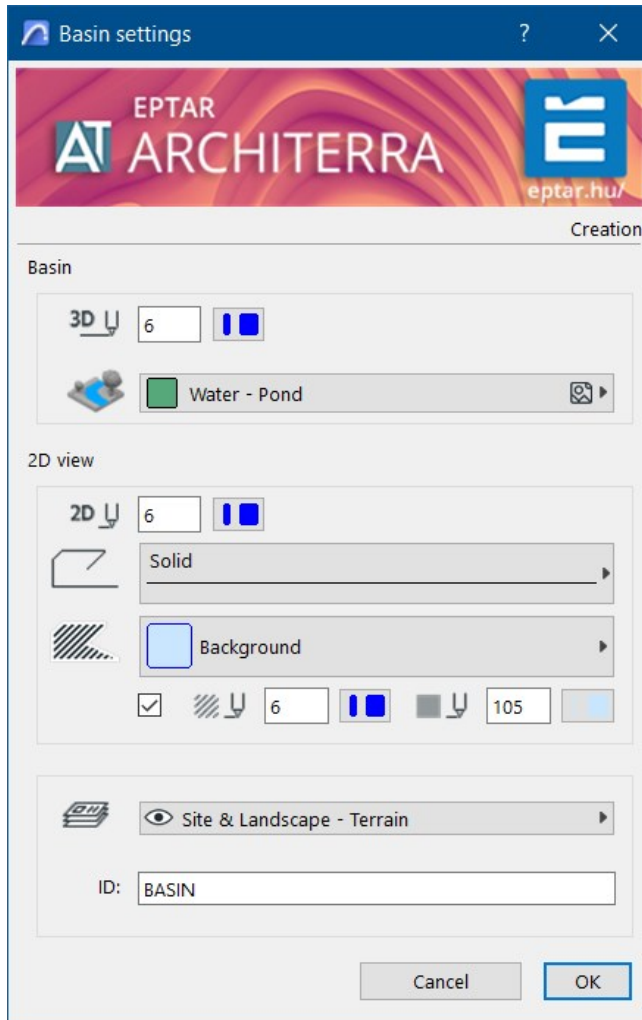

In the 2D View section, the user can select:

- The pen used for the outline of the basin in the map view.
- The line type for its outline.
- The fill used for the hatching the checkbox to activate hatching of the area covered by the basin.
- The pen used for the fill hatch the pen used for the fill background.

In the Listing Attributes section, users can define an identification string for the Basin. In the last pop-up menu, it can be selected the layer where the element to be created will be stored.

Confirm the modifications with the OK button and then, when the box closes, click with the cursor on a point on the terrain/mesh to define the altitude of the basin:

After a short process, the basin will immediately be displayed in the map and 3D views:

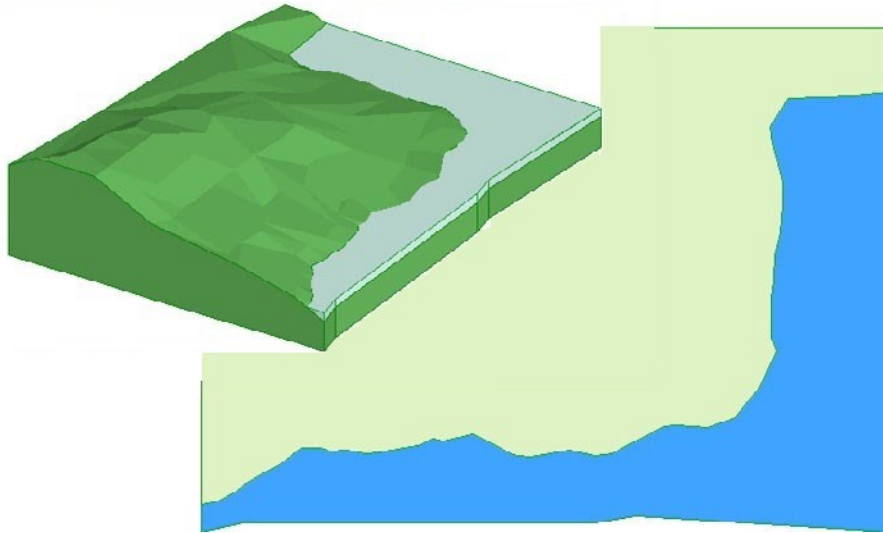

Building tool

Use this simple tool to generate the volume of buildings on the terrain.

The principle is simple: Define the solid perimeter to process using ARCHICAD graphic primitives (fills or polylines) and then transform the 2D perimeter into a three-dimensional element by defining the altitude.

After drawing (in the example below, using the ARCHICAD Fill tool) the perimeter of the building to be created, select it together with the terrain/mesh on which it stands:

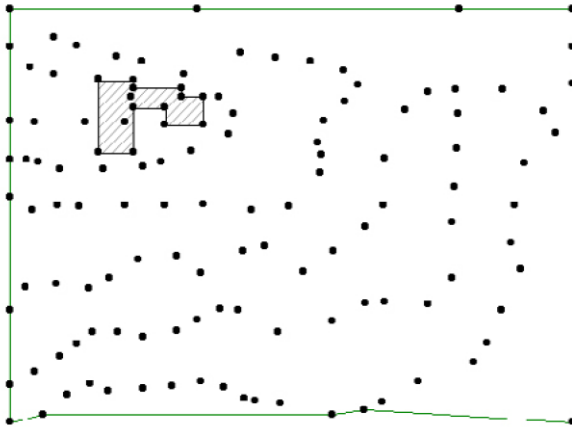

NOTE:

From this version it can be selected collectively more buildings together. Important is only that the selected buildings have the same altitudes.

Then click on the Building tool icon in the ArchiTerraPlus toolbox to display the *Building settings dialog box*:

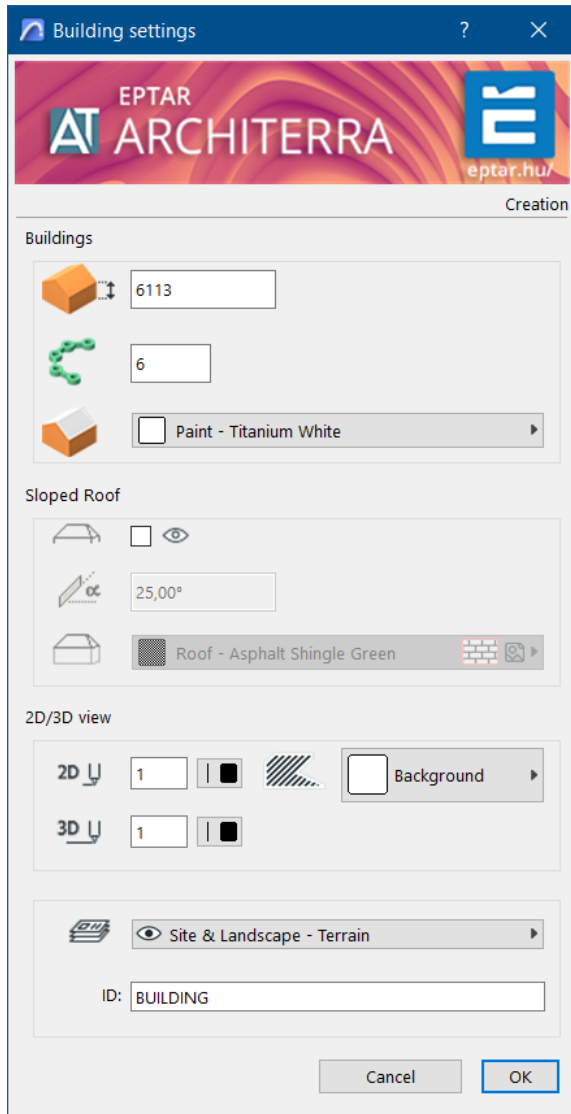

The first field defines the altitude of the eaves of the building to be created as the relative altitude (the height of the building, in other words, the distance from its lowest point to the line of the eaves).

The checkbox below activates/deactivates display of the roof. This is an automatic roof which will approximately represent the roof of the building to be created.

The following field defines the pitch of the roofs (if displayed). On the right, a whole value manages the approximation of any curved parts of the building to be created.

The subsequent pop-up menus allow the surface material used for the solid part and roof (if displayed) of the building to be defined.

In the 2D/3D View section, the user can configure:

- The pen used for the outline of the building in the map view.
- The pen used for the outline of the building in the 3D view.
- The fill used for the building in the map view.
- The pen used for the fill hatch.
- The pen used for the fill background.

Immediately below in the Listing Attributes section, it can be defined an identification string for the building object. The last pop-up menu defines the layer where the element will be stored.

IMPORTANT:

At the bottom left of the dialog box, there is a checkbox named cancel primitives.

If this checkbox is activated, when the dialog box is closed using the OK button, ArchiTerraPlus will automatically cancel the 2D primitives used to define the shape of the element from the worksheet. If the checkbox is left disabled, the primitives will not be automatically cancelled. Confirm the modifications with the OK button and ArchiTerraPlus will immediately insert the building calculated:

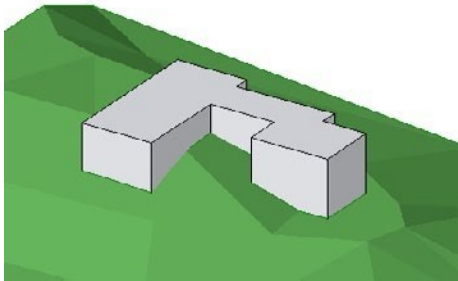

Building without roof

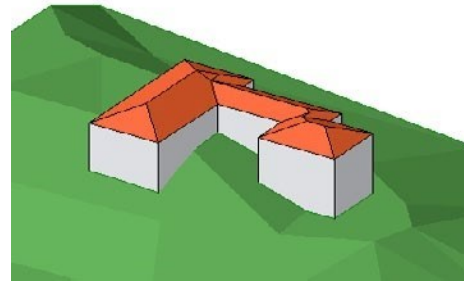

Building with automatic roof

Modify the buildings

Buildings are parametric objects (AT3_BUILDING) and can therefore be modified at any moment.

The shape can be modified following the steps below:

1. In the map view (or the 3D view) select the building by clicking on one of the perimeter nodes.
2. Click on the nodes, drag them and release them in the required position as it would be to modify any ARCHICAD polygonal element (Slabs, Fills, etc).

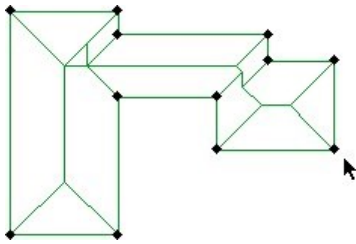

Selecting the building

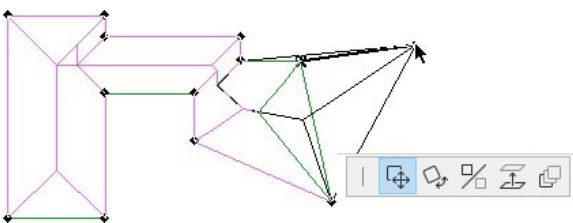
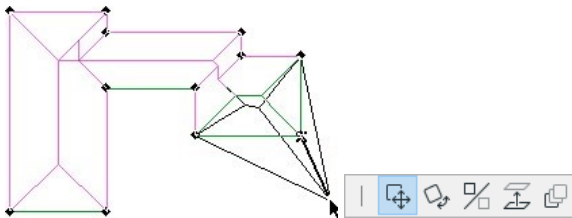

Dragging the nodes

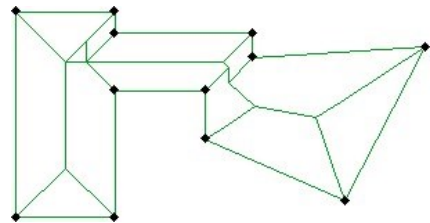

The modified building

Wall tool

The user can generate walls following the surface of the terrain with this simple tool.

IMPORTANT:

Be careful not to confuse ArchiTerraPlus walls with ARCHICAD walls. ARCHICAD walls are project building parts, ArchiTerraPlus walls are parametric library parts used for a different purpose.

To generate an ArchiTerraPlus Wall, use the ARCHICAD Polyline tool in the map view to define its reference line (which could include curved sides).

Then select this polyline and click on the Wall tool icon in the ArchiTerraPlus toolbox. The Wall Settings box will immediately be displayed:

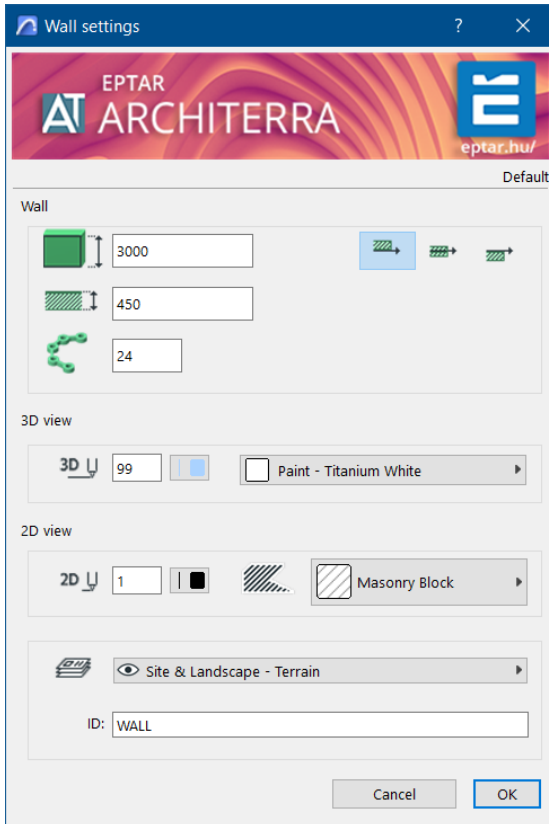

The user can define the height of the wall (constant along the full length) and its thickness, while the three buttons on the right define the position of the wall with respect to its reference line.

In the 3D View section, the user can configure:

- The pen used for the wall in the 3D view.
- The approximation for curved parts of the wall.
- The surface material used for the wall.

In the 2D View section, the user can configure:

- The pen used for the wall in the map view.
- The hatched fill of the wall in the map view.
- The pen used for the fill hatch.
- The pen used for the fill background.

In the Listing Attributes section, it can be defined an identification string for the wall object and in the last pop-up menu allows to define the layer where the element will be stored.

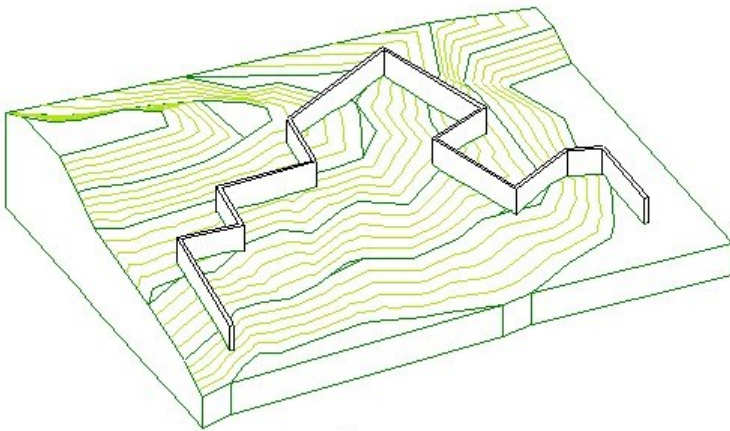

The altitudes of ArchiTerraPlus Wall nodes

When the reference line of an ArchiTerraPlus Wall is defined using the ARCHICAD polyline tool, the number and position of the nodes in the polyline are fundamental as ArchiTerraPlus uses these nodes to extrapolate the altitude of the base of the wall to generate. Here is an example to clarify this concept.

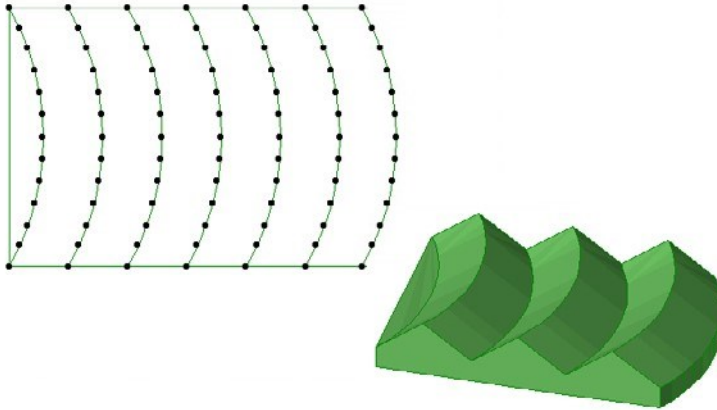

The previous image shows terrain with a zigzag altitude.

Now draw an ARCHICAD polyline consisting of three nodes only as shown in the following image:

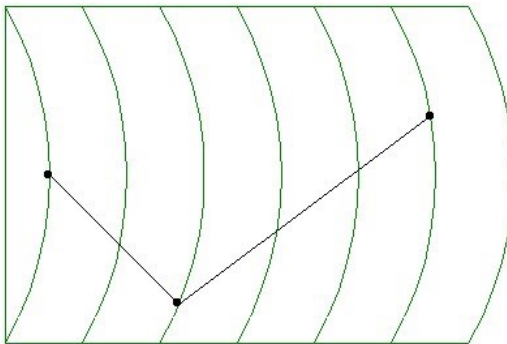

As explained above, when this polyline is transformed into an ArchiTerraPlus wall, ArchiTerraPlus will use the three nodes to acquire information on the altitudes of the terrain and then construct the resulting wall. Then select the polyline and the terrain/mesh and click on the Wall tool in the ArchiTerraPlus toolbox to display the Wall settings dialog box, confirming the default configuration.

The resulting wall will be similar to the following:

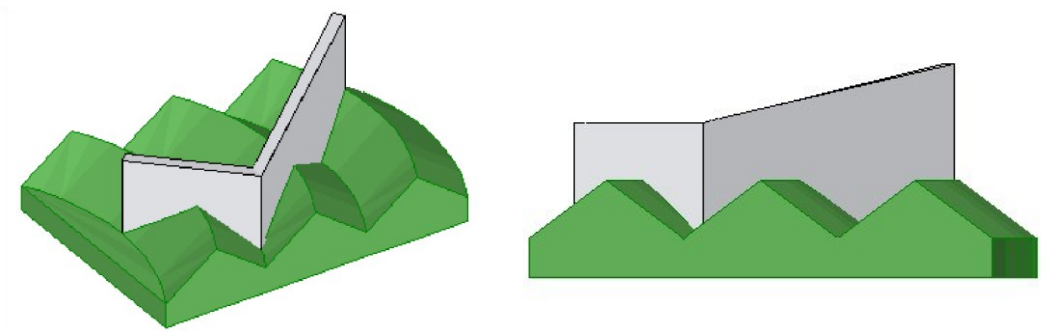

If the user draws another polyline using more nodes the result is significantly different:

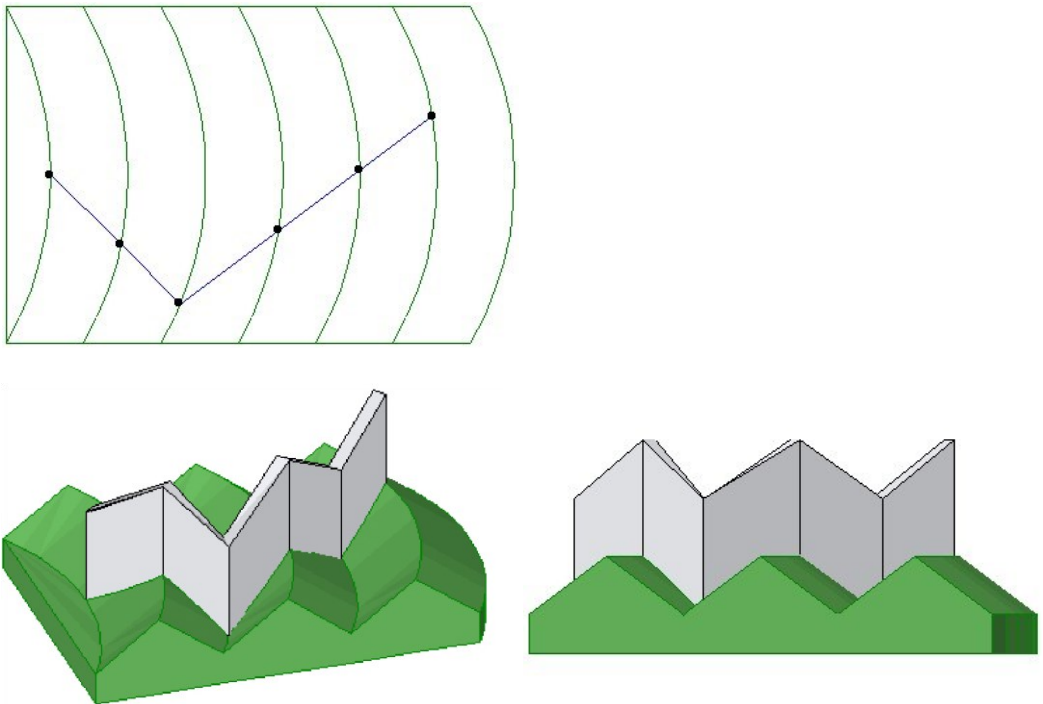

The user must therefore be careful when define the polyline for the wall reference line. The final result of the operation as ArchiTerraPlus will build the wall on the basis of the nodes in the polyline which the user drew.

TIP:

The Retaining Wall tool uses a completely different algorithm (explained in the following chapter) which automatically follows the course of the terrain altitude. It is up to the user decide in each case the most appropriate tool for the walls he/she wish to create on the terrain surface.

Modifying ArchiTerraPlus Walls

ArchiTerraPlus walls are parametric objects (AT3_WALL) and can therefore be modified at any moment.

The shape can be modified following the steps below:

1. In the map view (or the 3D view), select the wall by clicking on one of the nodes in the reference line.
2. Click on the nodes, drag them and release them in the required position as it would be to modify any ARCHICAD polygonal elements (Slabs, Fills, etc).

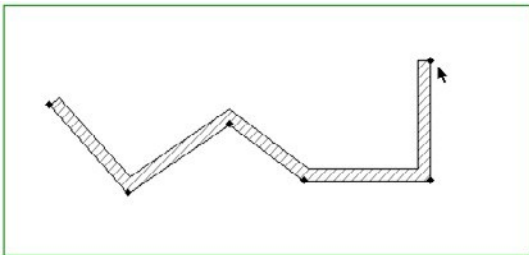

Select the ArchiTerraPlus wall

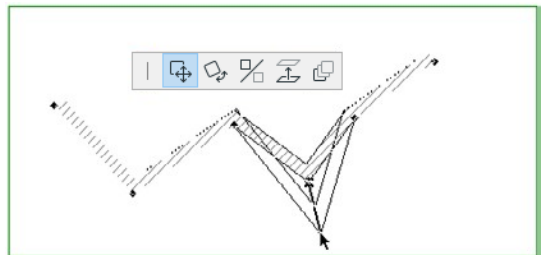
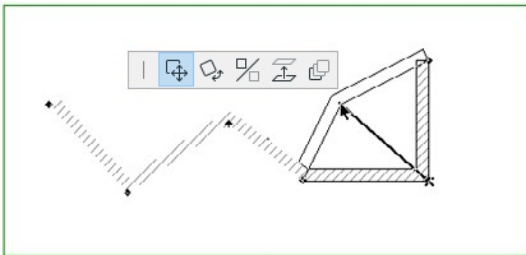

Moving the wall nodes

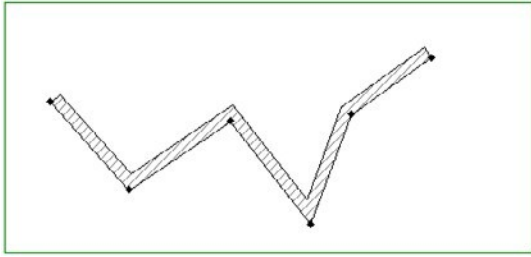

The modified ArchiTerraPlus wall

IMPORTANT:

Modifying the position of the nodes on the reference line introduces obvious incongruence in the information on the altitude of these nodes.

To update the altitudes of the moved nodes and then restore congruence with the terrain model, select the ArchiTerraPlus wall modified graphically and click on the Data Update icon in the ArchiTerraPlus toolbox.

The procedure used to modify the parameters of an ArchiTerraPlus wall is in every way similar to that used to modify any ARCHICAD library element:

1. Select the walls in the map view by clicking on one of the nodes of the reference line.
2. Click on the icon of the relative tool in the ArchiTerraPlus toolbox to display the settings dialog box.
3. Carry out the necessary modifications.
4. Confirm the modifications by closing the dialog box with the OK button.

IMPORTANT:

The wall object can also be used to draw fences or rails. These functions can be accessed by selecting the object and accessing its configuration by the ARCHICAD Object settings dialog box. Consult the Appendix for more detailed information on these characteristics.

Retaining Wall tool

The Retaining Wall can be used to draw walls which follow the course of the terrain or retain slopes in ArchiTerraPlus elements (just like actual retaining walls).

Creating a retaining wall

To generate a retaining wall, you first need to use an ArchiTerraPlus Polyline in the map view to define its reference line (which could include curved sides). The algorithm used to generate this type of wall is completely different from the one used for ArchiTerraPlus walls (as already noted in the previous paragraph).

The altitudes of the base of the wall are calculated precisely on the basis of variations in the altitude of the terrain.

To underline this characteristic, in the following example we have traced an ARCHICAD polyline consisting of just two nodes (at the ends) on terrain with a highly irregular altitude.

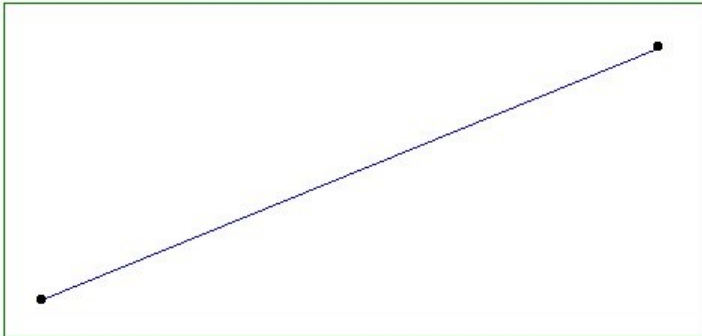

Select this polyline and click on the Retaining Wall tool icon in the ArchiTerraPlus toolbox.

ArchiTerraPlus immediately displays the following Retaining Wall settings dialog box:

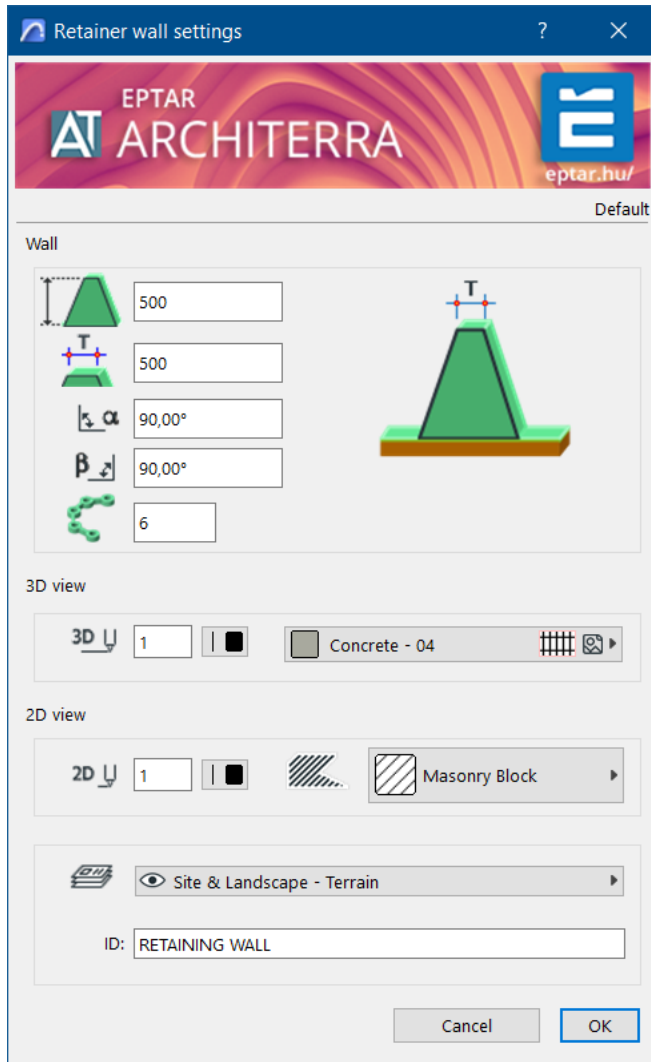

In the Wall section at the top you can define:

- The height of the wall (the distance between the altitude of the extrados and the altitude of the terrain on the reference line side).
- The thickness of the wall.
- The angle of the left surface (with respect to the reference line).
- The angle of the right surface (with respect to the reference line).

In the 3D View section, the user can configure:

- The pen to represent the element in the 3D view.
- The resolution of any curved sides.
- The surface material.

In the 2D View section, the user can configure:

- The pen to represent the element in the map view.
- The fill used in the map view.
- The pen used for the fill hatch.
- The pen used for the fill background.

In the Listing Attributes section, the user can define an identification string for the element. In the bottom pop-up menu, it can be chosen the layer where the element will be stored.

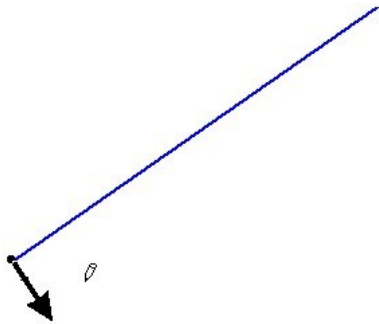

When the settings made are confirmed with the OK button, ArchiTerraPlus closes the dialog box and the cursor changes to an arrow at the start of the polyline used to generate the element.



If you move the cursor to the two sides of the polyline, the arrow changes direction, indicating the side on which the Retaining Wall will be constructed. Click on the required side and ArchiTerraPlus immediately generates the element requested.

Modifying Retaining Walls

ArchiTerraPlus retaining walls are parametric objects (AT3_RETAINING_WALL) and can therefore be modified at any moment.

Given the complexity of the element and its characteristics (following the land morphology), the shape of this type of element in the map view cannot be changed, but it can be graphically modify the height in the 3D window:

1. Select the retaining wall in the 3D window by clicking on one of its surfaces.
2. Click on the top nodes of the wall, drag them and release them in the required position as it would be to modify the height of any ARCHICAD GDL object.

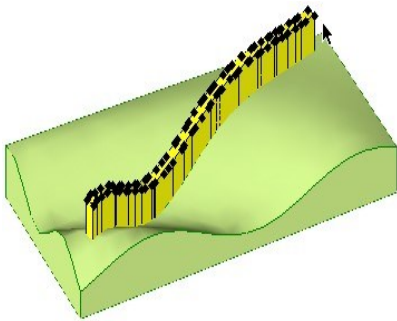

Select the ArchiTerraPlus retaining wall

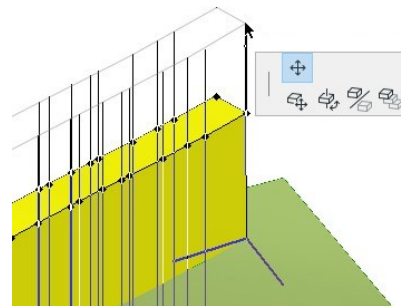

Moving the top nodes of the wall

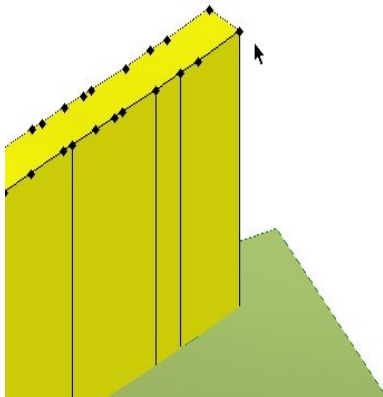

The modified ArchiTerraPlus retaining wall

Creating a retaining wall as an obstacle

As already mentioned, as well as creating single walls which follow the course of the surface of the terrain, a Retaining Wall can also be used as an obstacle to limit elements calculated on the terrain itself, just like a genuine retaining wall. Let's take a look at the following example:

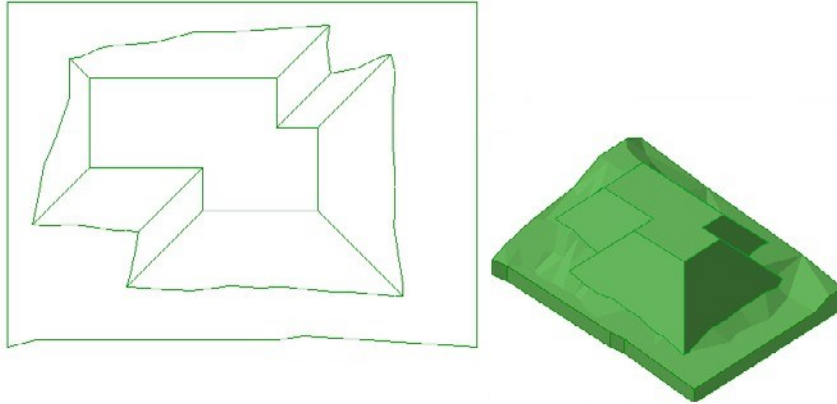

Here you can see a terrain/mesh with a plateau whose scarps rest on the majority of the terrain. Suppose that the scarps on the bottom and right sides of the map must be limited as shown by the dotted line in the following image:

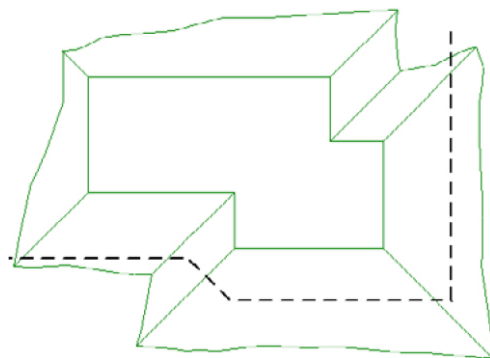

Limiting elements using a Retaining Wall is quite easy.

Firstly, we can only limit elements which have already been “constructed” on the terrain. The logic is that it must first “construct” the element, then subsequently “limit it”.

Use an ARCHICAD polyline to define the obstacle (take care to use open polylines only!). Then proceed as follows:

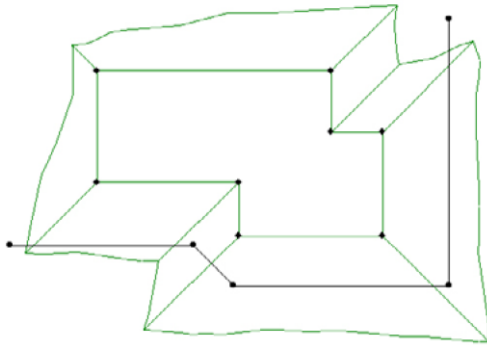

Select the element to be limited (in our example, a plateau) and the polyline representing the obstacle and then click on the Retaining Wall icon in the ArchiTerraPlus toolbox.

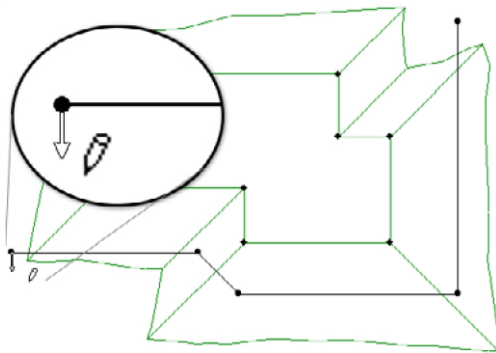

Once clicked the Retaining Wall icon, the procedure begins and the cursor changes to an arrow at the start of the polyline used to generate the obstacle.

Click on the wanted part to limit/eliminate and ArchiTerraPlus immediately limits the intervention along the selected polyline and insert the Retaining Wall.

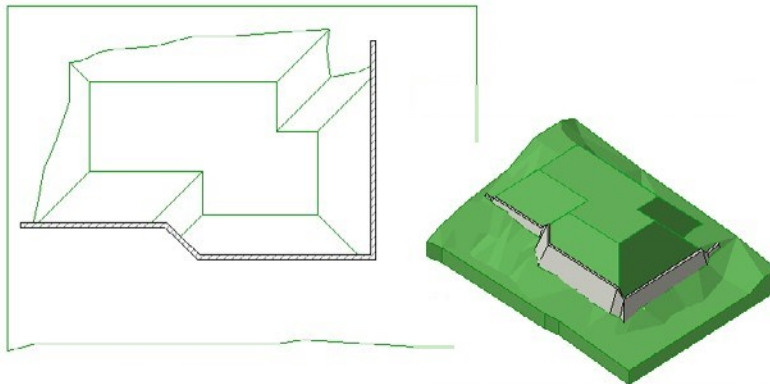

The following diagram shows the meaning of the values in the Wall section of the Retaining Wall settings dialog box:

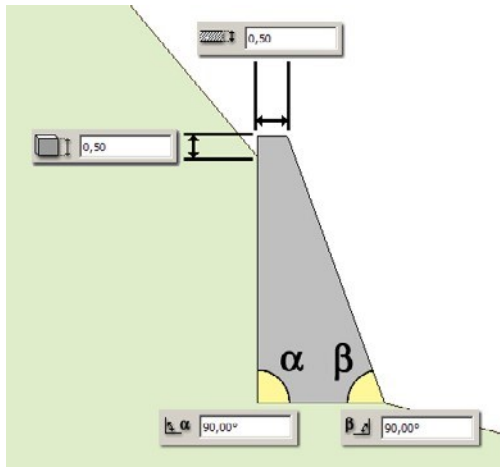

Coloured Area tool

The user can use this simple tool to colour the terrain surface.

The perimeter of the coloured area can be define using an ARCHICAD fill and ArchiTerraPlus colours the terrain following the settings.

NOTE:

This version uses a single highly parametric object (AT3_PAINTER) for each piece of terrain to manage all the coloured areas defined by the user. Define the surface (or surfaces) to be coloured in the map view using ArchiTerraPlus fills.

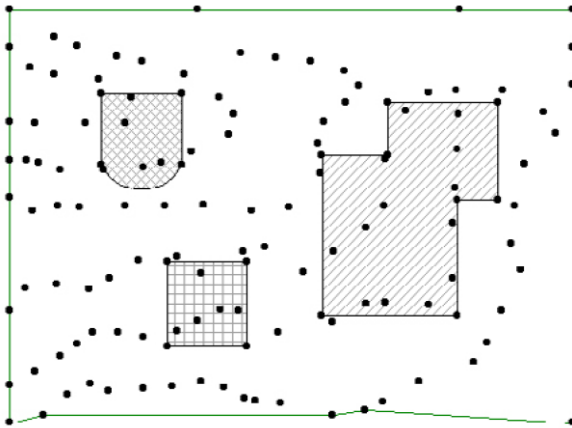

TIP:

Use different fills (or different pens) if colour a number of separate areas at the same time. This enables to distinguish the various surfaces (and thus assign the correct attributes) in the fill list in the coloured Area settings dialog box.

Select the fill (or fills) and click on the coloured Area tool icon in the ArchiTerraPlus toolbox.

You will immediately have access to the *coloured Area settings dialog box*:

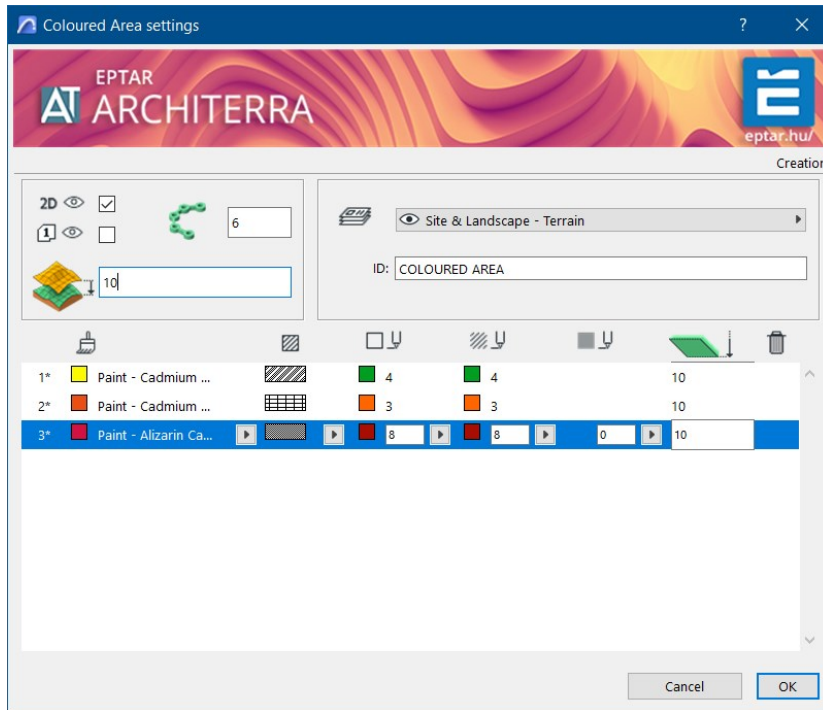

In the coloured Area settings dialog box, there is a list of all the fills and their assigned attributes. The information listed in the columns are, from left to right:

- Progressive number of the surface.
- Material used for the surface.
- Fill used in the map view to represent the surface.
- Pen used for the fill out line in the map view.
- Pen used for the fill hatch in the map view.
- Pen used for the fill background in the map view.
- Elevation of each individual coloured surface with respect to the terrain.

To edit the values of a line, click on the line to select it and use the fields to define the values. The two top sections of the dialog box are used for general configuration of the object representing the coloured areas. At the top left, there are:



A check-box to show/hide the coloured areas in the map view.



A check-box to show/hide the progressive numbers of the individual coloured areas. Activate it to highlight the correspondence between the coloured areas in the map view and those listed in the list in the coloured Area settings dialog box.



Global elevation of the colored surface with respect to the terrain. Use this value to modify the global position of the coloured areas with respect to the terrain with a single setting.

At the top right the user can:

- Configure the resolution of curved parts of the coloured areas.
- Define an identification string for the coloured Area object (AT3_PAINTER).
- Choose the layer where the element will be stored.

IMPORTANT:

At the bottom left of the dialog box, there is a check-box named cancel primitives.

If this check-box is activated, when the dialog box is closed using the OK button, ArchiTerraPlus will automatically cancel the 2D primitives used to define the shape of the element from the worksheet.

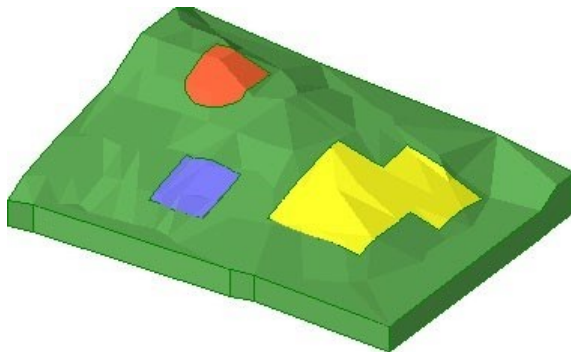

Modifying colored Areas

Coloured areas are managed by a parametric object (AT3_PAINTER) and can therefore be modified at any moment. The shape can be modified following the steps below:

1. Select the coloured areas in the map view by clicking on one of the edge nodes.
2. Click on the nodes, drag them and release them in the required position as it would be to modify any ARCHICAD polygonal elements (Slabs, Fills, etc).

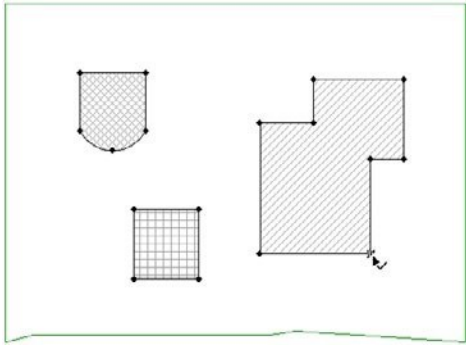

Selecting the coloured areas

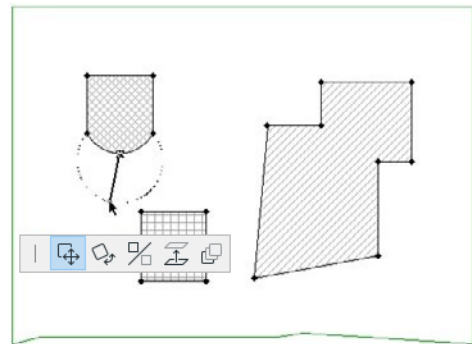
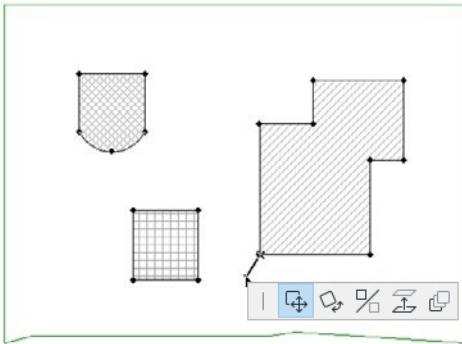

Dragging the nodes

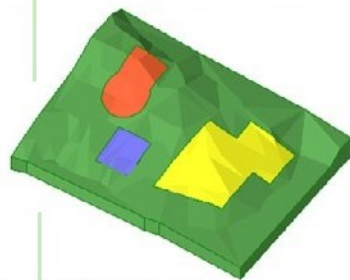
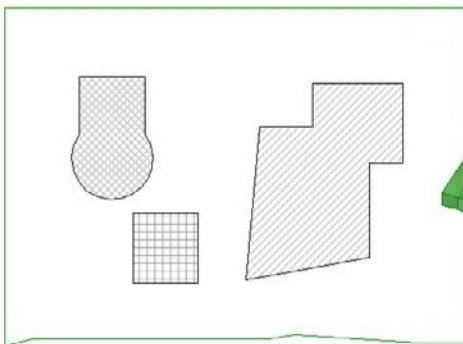

The modified coloured areas

Managing overlapping-coloured areas

When there are overlapping coloured areas, if they are not specifically configured, the result in the 3D view will not be satisfactory.

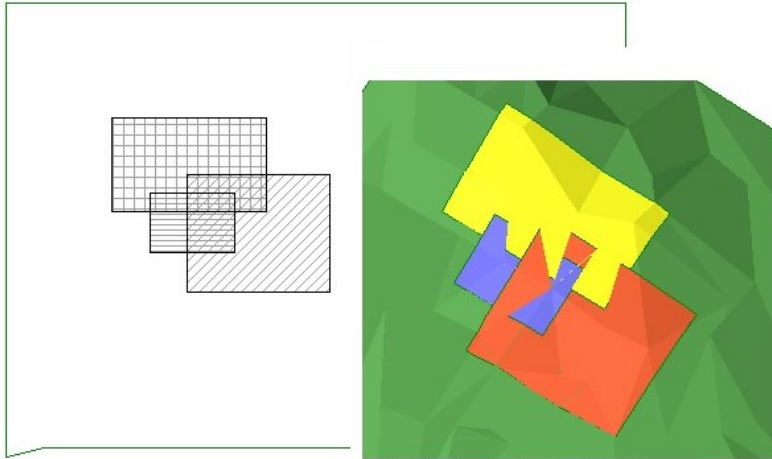

From a software point of view, this is easy to understand as the three areas are at the same level and therefore interpenetrating.

The problem is simple to resolve. Just act on the level of the three areas in such a way as to distribute them along the Z axis. The highest surfaces will have priority over lower ones. Then select the object representing the coloured Areas in the map view and click on the icon corresponding to the relevant tool in the ArchiTerraPlus toolbox.

As no configuration was performed at the moment of creation, the elevation fields of the individual areas are configured to zero.

Let's imagine the user want to give the purple surface maximum priority, followed by the yellow surface, then the red surface.

1*	Paint - Cadmiu...		1	82	1	0	
2*	Paint - Ultramar...		1	82	1	0	
3*	Paint - Cadmiu...		1	82	1	0	

The elevations of the three overlapping surfaces must be suitably configured so that the purple is the highest, followed by the yellow, leaving the red in the current position:



Here is the new result in the 3D view:

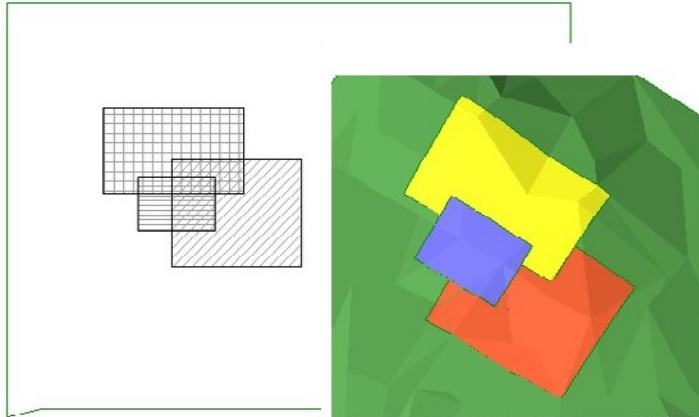

Modify X-Y coordinates/modify Z coordinate toggle

This is also a simple toggle used in the 3D view to switch from graphic editing of the X-Y coordinates to graphic editing of the Z coordinate.

A click on the tool icon after selecting the object to modify will simply and easily switch from editing the position of the nodes on the horizontal plane to editing those on the vertical plane. Here is a simple example using a plateau:

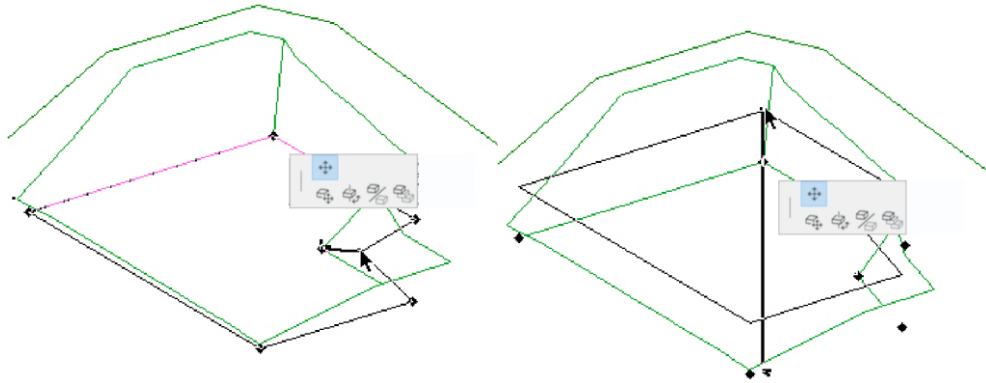

Graphic editing of a node on the horizontal plane

Graphic editing of a node on the vertical plane

Calculate tool

One of the most interesting characteristics of ArchiTerraPlus is the possibility of calculating the quantity of earth moved following interventions on the terrain.

Firstly, it is important to remember that the calculation of quantities must be updated each time to take account of possible graphic modifications performed by the user as part of the project.

The Calculate tool is used for this purpose. It updates all data to faithfully reflect the current situation.

This starts the procedure (which requires a few seconds of processing) to update the quantities relating to the terrain selected.

At this point, the user can use the “Base (ArchiTerraPlus_DB)” components list located on the Navigation bar of ARCHICAD to view the quantities associated with the interventions on the terrain:

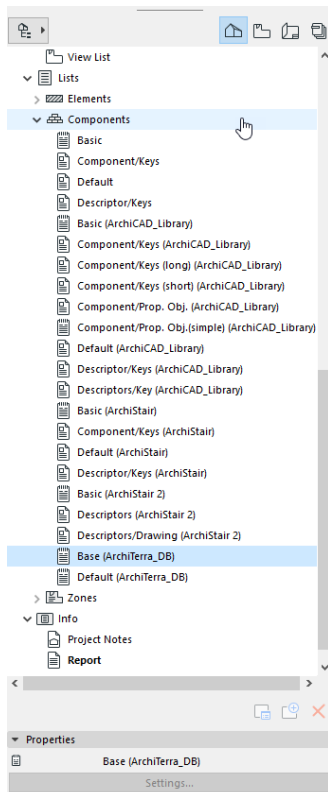

TERRAIN 01		DESCRIZIONI	SCAVO	RIPORTO
TERRAIN 01				
TERRAIN 01	001	PLATEAU 01	1.262,34 m3	83,90 m3
TERRAIN 01	002	PLATEAU 02	0,00 m3	6.374,63 m3
TERRAIN 01	003	PLATEAU 03	7.076,06 m3	534,48 m3
TERRAIN 01	004	ROAD 01	350,44 m3	651,05 m3
TERRAIN 01		TOTALI	8.688,84 m3	7.644,06 m3
TERRAIN 02				
TERRAIN 02		DESCRIZIONI	SCAVO	RIPORTO
TERRAIN 02	001	PLATEAU 05	27.692,77 m3	0,23 m3
TERRAIN 02	002	PLATEAU 06	6,62 m3	2.363,05 m3
TERRAIN 02		TOTALI	27.699,40 m3	2.363,28 m3

The above table clearly shows the importance of the identifying strings associated with the terrain/mesh and other elements or operations (excavations and roads). The first column gives the ID string identifying the terrain for which the quantities are displayed, while the second column gives the name of the element or operation calculated.

Gravity on Terrain, Insert Objects

The Gravity on Terrain tool enables users to position ARCHICAD library elements precisely on the surface of the terrain.

This could also seem to be a duplicate of a function already present in ARCHICAD. This is not in fact the case, for the same reasons as explained for the Spot Heights tool. The ARCHICAD gravity function always refers to the original points on the surface of the mesh and not to the surface resulting from modifications made with Solid Elements Operations (see the description in the Spot Heights tool for more detail).

To use the Gravity on Terrain function just follow the steps below:

1. Click on the Gravity on Terrain tool.
2. ArchiTerraPlus immediately displays the following *Object settings dialog box* where you can select and configure the library element you wish to insert.
3. Confirm the configuration with the OK button and select the library element.
4. In the map view, click on the surface of the terrain/mesh to insert the object at those coordinates and at the altitude of the land at that point.

This starts the object insertion cycle and each time the user clicks on the worksheet, a further object with the characteristics previously defined is inserted on the surface of the terrain.

To exit from the insertion cycle, click on Cancel in the ARCHICAD control bar or Esc on the keyboard (as well as all the other standard ways in the ARCHICAD interface).

Spot Heights tool

The Spot Heights tool allows to display the data associated with the points/hotspots of the terrain/mesh and to attribute spot heights to your terrain/mesh.

In the former case, displaying the information memorized in the points, its usefulness is clear as ArchiTerraPlus uses simple ARCHICAD hotspots to represent the points and without this tool there would be no other way to view this information. When used to attribute spot heights to the terrain/mesh, it could seem to be a duplicate of the tool already present in the standard ARCHICAD toolbox. In fact, this is not the case. Here is a simple example, without using ArchiTerraPlus, of correct use of the tool in ARCHICAD.

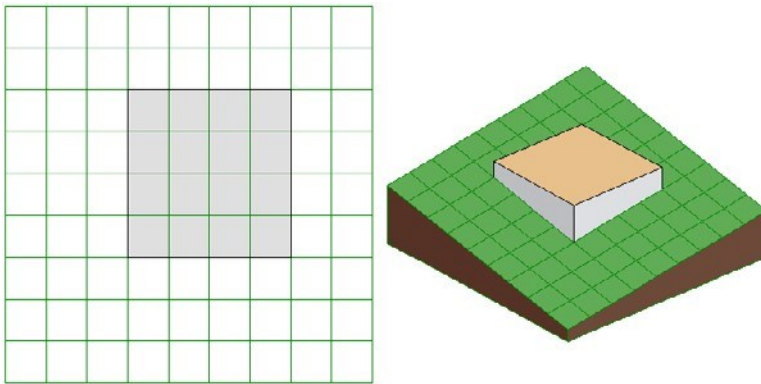

The above image shows a simple Mesh constructed with ARCHICAD into which a Slab has been inserted.

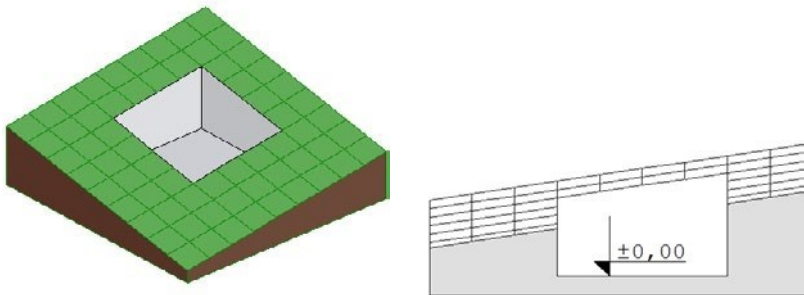

Using Solid Elements Operations, the volume of the slab is subtracted from the mesh: As can be seen in the cross section, the altitude of the mesh corresponding to the plateau obtained by subtracting the volume of the mesh is 0.00 meters.

We will now attribute spot heights to that zone of the mesh using the ARCHICAD Spot Heights tool and activating gravity to the mesh in order to view the level of the surface of the mesh at the points clicked:

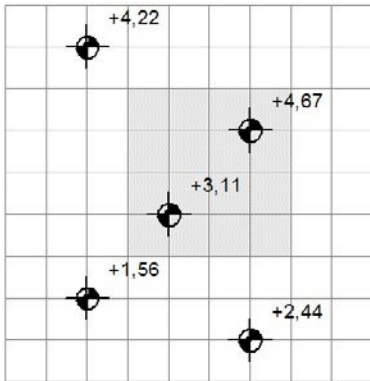

As can be seen in the image, ARCHICAD still attributes spot heights at the original surface altitude (prior to the Boolean subtraction operations) without considering the modifications made using Solid Elements Operations.

As described before, all modifications which can be made by ArchiTerraPlus on terrains/meshes are based on Solid Elements Operations and therefore the tool should be able to correctly attribute spot heights to the terrain, taking modifications made to the surface of the mesh into consideration.

Attributing spot heights to survey points

Spot heights are attributed to survey points, in other words the points/hotspots used to construct the terrain/mesh, automatically.

Let's suppose we want to view the information on the points used to construct the terrain/mesh in the following image:

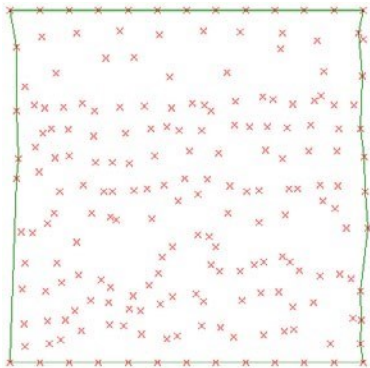

Without selecting any object (so ArchiTerraPlus understands it must initiate the procedure to display the information on the points/hotspots present on the worksheet), click on the Spot Heights tool in the ArchiTerraPlus toolbox.

ArchiTerraPlus immediately displays the Spot Heights settings dialog box:

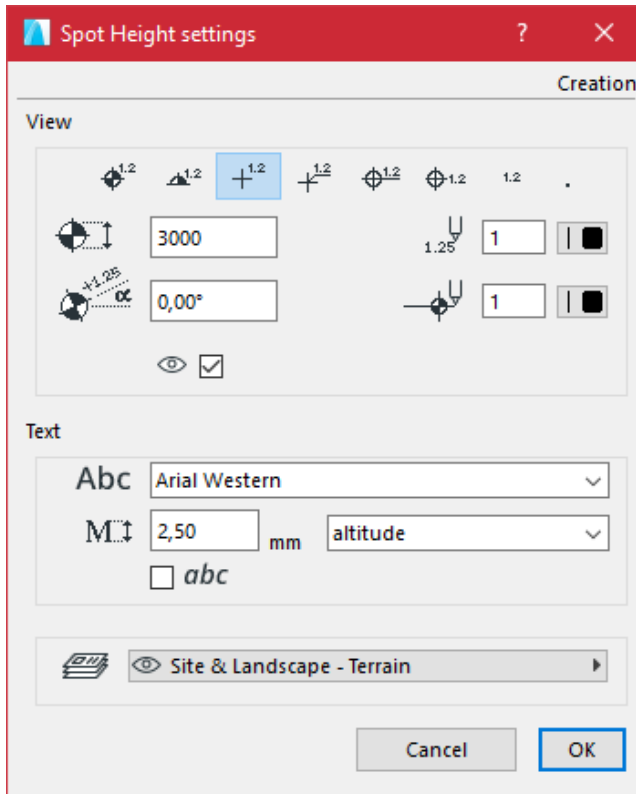

In the View section, it can be configured the appearance of the marker by choosing the style and defining the dimensions, angle and pen used to draw it. In the Text section, it can be chosen the font, size of character and possible use of italics for the string of information to be displayed.

The three radio buttons on the right define the information to be displayed:

Altitude: The altitude of the point will be displayed alongside.

Marker code: The code of the point will be displayed alongside the marker altitude.

Code: The altitude and the code of the point will be displayed alongside the marker.

The Map with spot heights section will be described below. In this case the options are disabled. The last pop-up menu allows the user to choose the layer where the GDL object (AT3_POINT_MARKER) used to represent the altitudes on the map will be stored.

Here is the result:

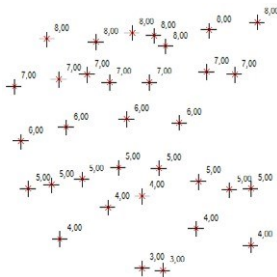

IMPORTANT:

The information displayed relates to the points/hotspots in the map view worksheet. If the terrain/mesh has been modified subsequently, the spot heights will not correspond to its surface. It must be emphasized that this procedure has in any case been conceived to view information associated with the points/hotspots and NOT the terrain/mesh they generate.

Attributing spot heights to the terrain

The procedure for attributing spot heights to points on the terrain/mesh (required to have correct altitudes even when using Solid Elements Operations), is as simple as the standard ARCHICAD procedure:

1. Firstly, select the terrain/mesh for which you want to view the spot heights.
2. Click on the Spot Heights tool in the ArchiTerraPlus toolbox.
3. In the Spot Heights settings box which appears, configure the parameters as required.

NOTE:

In this case, the three radio buttons to select the type of information to display are not available. We are in fact viewing the spot heights of “random” points which do not correspond to the points/hotspots used to generate the terrain and which may include a code as additional information. The only information which can be displayed is the altitude of the point.

4. During this procedure, the Map with spot heights option is active, but we will skip it as it will be described in the next topic.
5. Close the settings dialog box and confirm configuration of the spot heights by clicking on the OK button.

The shape of the cursor changes (pencil cursor) and ArchiTerraPlus waits while it is defined the point for which the user wants to view the spot height by clicking on the terrain/mesh previously selected.

The procedure is cyclic. After it has been clicked, ArchiTerraPlus displays the spot height and waits for the user to click again before inserting another.

To exit from the procedure, click on Cancel in the ARCHICAD control bar or Esc on the keyboard (as well as all the other standard ways in the ARCHICAD interface). Each spot height inserted is a parametric GDL object (AT3_POINT_MARKER) which can be individually selected and edited to modify the parameters again, select them and click on the Spot Heights tool icon, modify the values, and confirm with the OK button.

Creating maps with spot heights

A map with spot heights is a regular grid of spot heights describing the contours of the terrain.

The usual Spot Heights settings dialog box appears. All the other parameters operate in the way described above and here we will describe the characteristics of the Map with spot heights section only.

The first checkbox enables this option. If the checkbox is disabled, the procedure is used to enter individual spot heights, if it is enabled, the procedure defines the map with spot heights.

The two bottom fields define the horizontal and vertical grid size, in other words, the distance along the X and Y axes between each successive altitude.

NOTE:

The spot heights must be extrapolated by ArchiTerraPlus by processing the model of the terrain. The denser the grid of the map with spot heights, the longer it will take to process the AT3_POINT_MARKER object.

Confirm the configuration by clicking the OK button. ArchiTerraPlus closes the dialog box and changes the shape of the cursor (pencil) waiting for the click on the terrain/mesh to define where in the map the spot heights will be inserted (in practice, the point indicated by the click will be one of the points on the grid of spot heights).

ArchiTerraPlus immediately displays the following message: “Indicating the number of spot heights which will be generated (and therefore calculated) for the map with spot heights being inserted”.

Click on Yes to accept the processing and after a suitable processing time (depending on the quantity of spot heights to be calculated and your hardware configuration), the map with spot heights will be inserted in the map view.

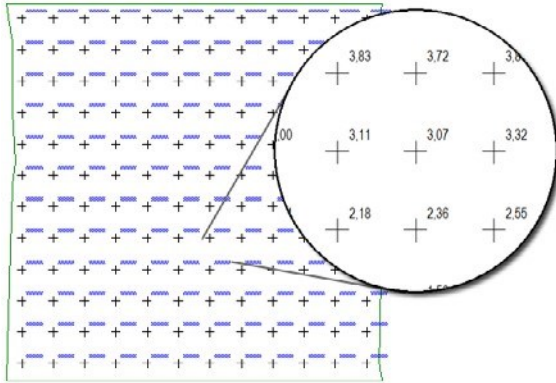

In this case, the entire map with spot heights is represented by a single AT3_POINT_MARKER object. To modify the characteristics, select the AT3_POINT_MARKER object and click on the Spot Heights tool icon, modify the parameters, and confirm with the OK button.

IMPORTANT:

The spot heights in this version of ArchiTerraPlus cannot be updated (in other words, the spot height displayed is not updated when the terrain is modified). If you modify the land morphology, simply cancel the spot heights (whether individual or part of a map with spot heights) and reposition them to reflect the current situation.

Camera tool

The user can use this tool to define Fly-Through routes so that each camera is automatically positioned on the surface of the terrain/mesh selected.

Let's look at a simple example of operation.

The following image shows a terrain/mesh in which a road has been drawn:

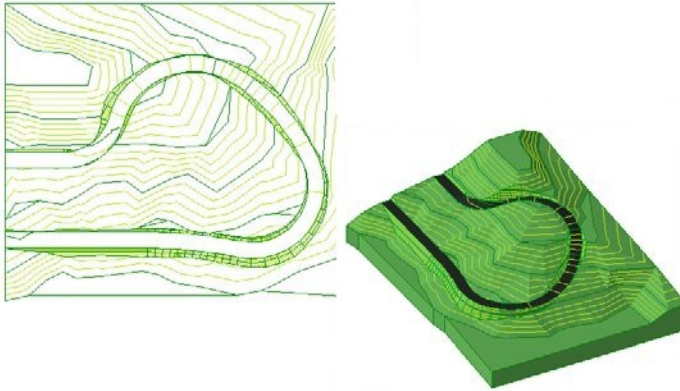

The aim is to create a route along the road which simulates what a driver on that road would see.

Firstly, use the ARCHICAD polyline tool to draw the desired route to create in the map view. Remember that the camera distribution procedure does NOT consider curved sections, in other words, if curved sides are present, it considers the chord joining the two ends of the arc.

It should be therefore avoided use curves (or remember that they will be approximated as described).

Here is the route to be transformed drawn with an ArchiTerraPlus polyline:

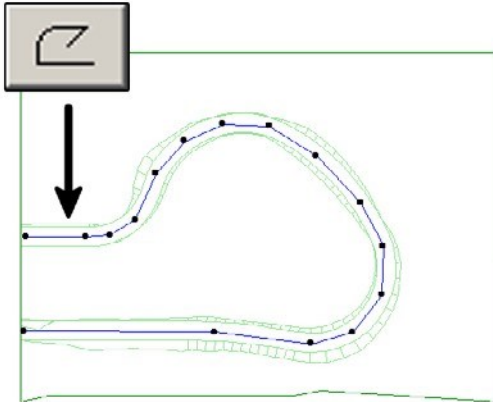

Next, select the ARCHICAD polyline defining the route where the cameras will be distributed and finally click on the Camera tool icon in the ArchiTerraPlus toolbox.

ArchiTerraPlus immediately displays the Camera settings dialog box:

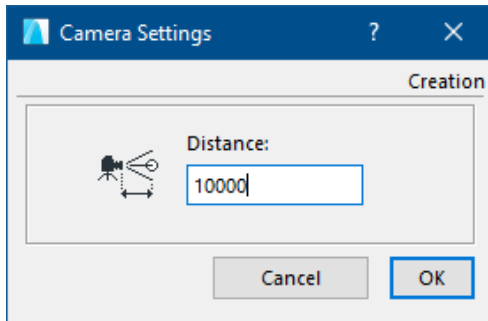

This dialog contains a single parameter the approximate distance between each camera along the route. Enter a value and confirm with the OK button.

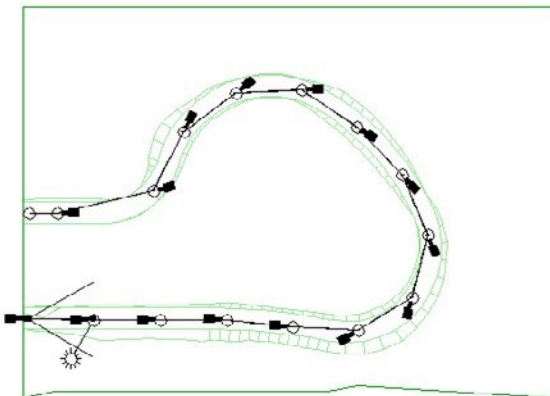

NOTES:



The two elevation values for the camera point of view and focus are configured by ArchiTerraPlus based on the current camera tool settings and the altitude of the terrain/mesh at the insertion point. In practice, the altitude of the terrain has been added to the current default values of the camera tool.

Following the example below, the camera must be positioned at a point on the terrain at an altitude of 23.50 meters:



The current settings of the camera tool.



The two values for the camera inserted by ArchiTerraPlus.



The current settings of the camera tool.



The two values for the camera inserted by ArchiTerraPlus.

IMPORTANT:

As described above, the Camera tool is used to generate routes only. To modify the settings for the route or individual cameras, use the standard ARCHICAD procedure.

ArchiTerraPlus tool default settings

As with any other programs, ArchiTerraPlus has default settings for pens, fills, layers, values, etc. Each time the user starts up ARCHICAD, ArchiTerraPlus reads these default settings and proposes them in the various settings dialog boxes.

It could therefore be useful to configure “the own” ArchiTerraPlus settings to automatically propose the most commonly used pens, fills, etc. And this is exactly what the ArchiTerraPlus Default Tool Settings tool is for. To customize your ArchiTerraPlus, configure all the dialog boxes as you prefer, setting your standard values and attributes. When you have completed this phase of configuration, click on the *ArchiTerraPlus Default Tool Settings tool* to view the following dialog box:

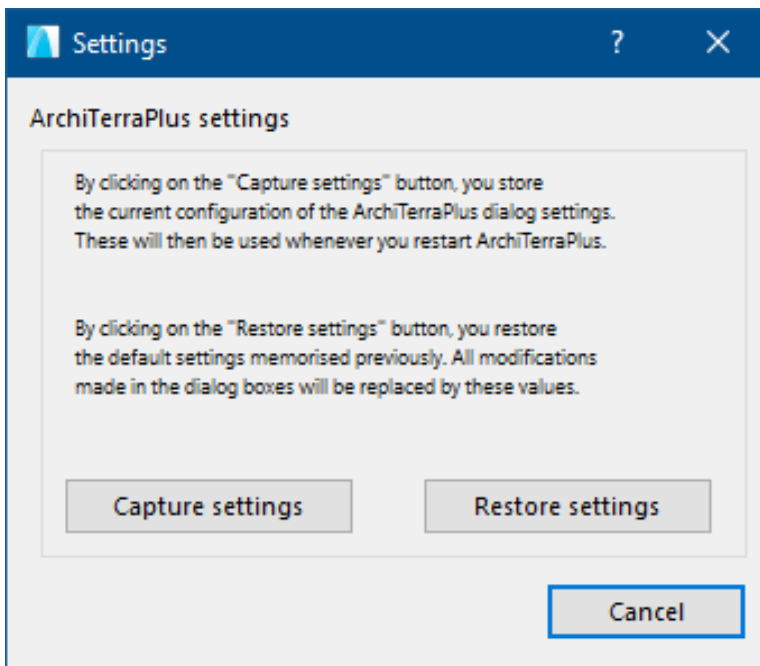

Click on the Capture Settings button to memorize the current configurations which will then become the default settings for the ArchiTerraPlus. All this information will, in fact, be memorized in the AT3_PREFS GDL object used by ArchiTerraPlus during initialization to set the default values. To reset the original default values for all values and attributes used by ArchiTerraPlus, click Restore Settings. Click on the Cancel button to close the dialog box without modifying the programme settings.

Help tool

Click on this button to view the user manual in pdf format.

To function correctly, it must have Acrobat Reader installed on the computer and the relative help document in pdf must be in the same folder as the ArchiTerraPlus add-on.

Appendix

This section of the manual takes a more detailed look at several subjects already covered in the manual:

- Data Update Tool.
- ArchiTerraPlus library elements.
- Multiple use of the AT3_CONTOURLINES object.
- Further characteristics of the ArchiTerraPlus wall.
- Customizing trunks and leaves.
- Problems with Solid Elements Operations.
- SOSI Files Import.

Data Update tool

As has been described several times in the previous chapters of this user guide, this tool is used to update data on the worksheet, integrating it with the latest modifications introduced by the user.

Depending on the situation and contents of the selection, it may produce various results.

The following list sums up its possible uses.

Updating altitudes

If the user selects a terrain and the relevant ArchiTerraPlus altitudes, those altitudes will be updated.

Updating ArchiTerraPlus walls

If the user selects one or more ArchiTerraPlus walls, the altitudes of the intrados of the wall (the level on which it rests) will be updated to correspond to the modified terrain.

Updating the element preview

If the user selects one or more walls and terrains/meshes, the preview of the elements will be updated (if it has not already been updated automatically).

Updating a basin

If the user selects a basin, this will be updated to conform to any modifications made to the terrain/mesh on which it is inserted.

Updating a road longitudinal section

If the user selects a road in the map view, the corresponding longitudinal section data will also be updated conform to the road modified on the map. Updating a road on the map if the user selects the longitudinal section of the road, the original data of the road on the map will be updated to conform to the road modified in the section view.

Updating all elements

If the user selects any element, its perimeter on the terrain will be updated. The following explanation uses a plateau.

The following image shows a “correct” plateau calculated on a terrain/mesh:

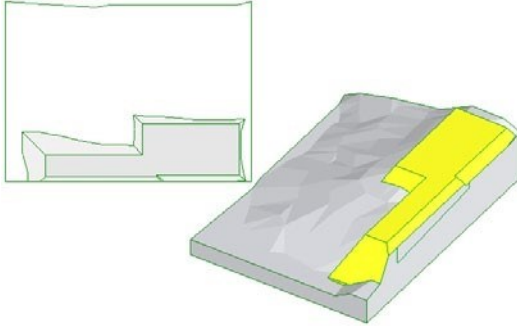

If the perimeter of the terrain is modified subsequently (in the following image, the hatched part of the map indicates the new perimeter of the terrain), for example by creating indentations, the result will be a “projecting” terrain as the shape of the original perimeter has been modified:

If you select the plateau and click on the Data Update tool, the list of terrain perimeter nodes will be updated, and the element will be displayed correctly:

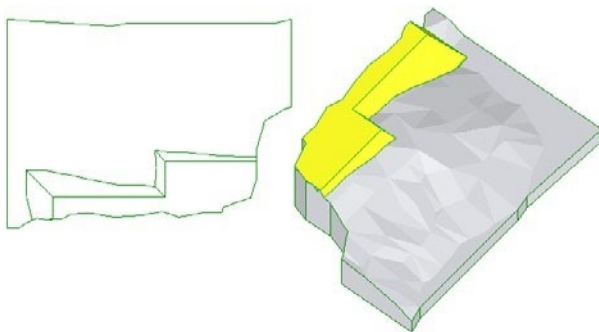
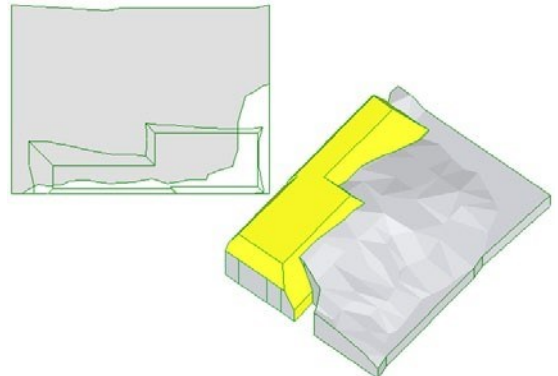

ArchiTerraPlus library elements

The ArchiTerraPlus library contains a series of objects used by ArchiTerraPlus to modify terrain or represent operations and elements. The main folder contains the following elements:

AT3_CONTOURLINES.gsm: Used for contour lines, the function shows depth and a preview of elements and operations.

AT3_PREFS.gsm: Used to memorize ArchiTerraPlus default settings.

AT3_ROAD.gsm: Used to create and represent roads.

AT3_SIDEWALK.gsm: Used to create and represent pavements.

AT3_RETAINING_WALL.gsm: Used to create and represent retaining walls.

AT3_PAINTER.gsm: Used to represent colored areas.

AT3_SLOPED_PLATEAU.gsm: Used to create and represent sloped plateau AT3.

AT3_BASIN.gsm: Used to create and represent basins.

AT3_LEVEL_MARKER.gsm: Used to represent spot heights on the terrain and maps with spot heights.

AT3_WALL.gsm: Used to create and represent walls, fences, and guardrails.

AT3_POINT_MARKER.gsm: Used to display information on the points/hotspots used to generate the terrain.

AT3_PLATEAU.gsm: Used to create and represent horizontal plateau.

AT3_BUILDING.gsm: Used to represent buildings.

AT3_OBSTACLE.gsm: Used to manage element obstacles.

SS_TREE folder: Folder containing the library elements required to create and represent random trees.

IMGs folder:

Folder containing images of the library elements user interface dialogs.

MACROs folder:

Folder containing the macros required for the functioning of other objects.

Skipping the contents of the IMGs and MACROs folders, the SS_TREE folder (used to generate random objects) contains the following:

SS_TREE.gsm:

The random tree object

MASTER_GDL_AT30_MAT.gdl:

The GDL macro which, in ARCHICAD, automatically

Leaves styles folder:

Folder containing the various leaf objects/styles.

Tree macros folder:

Folder containing the macros used in the tree object.

Tree textures folder:

Folder containing the textures used in the standard default materials for a random tree.

Trunk styles folder:

Folder containing the various trunk objects/styles.

Further characteristics of the ArchiTerraPlus wall

As mentioned in the chapter describing the ArchiTerraPlus Wall tool, once this library element has been processed and positioned in the map view by ArchiTerraPlus, the user can modify its characteristics by exploiting its parametric qualities.

When the user selects the AT3_WALL object plan view (or 3D view), it can be displayed the standard ARCHICAD Object settings dialog box to access these characteristics:

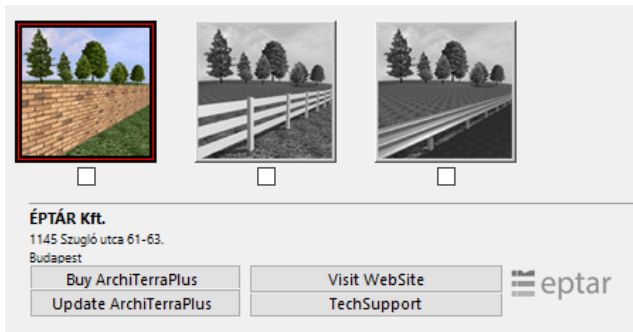

The three buttons determine functioning of the object, from left to right:

Wall function: Standard use of the element. This is used to represent walls on the terrain.

Fence function: The object used to represent fences on the terrain.

Guardrail function: The object used to represent guardrails on the terrain.

When the user choose either the Fence or Guardrail option, a further button is displayed to customize the element settings:

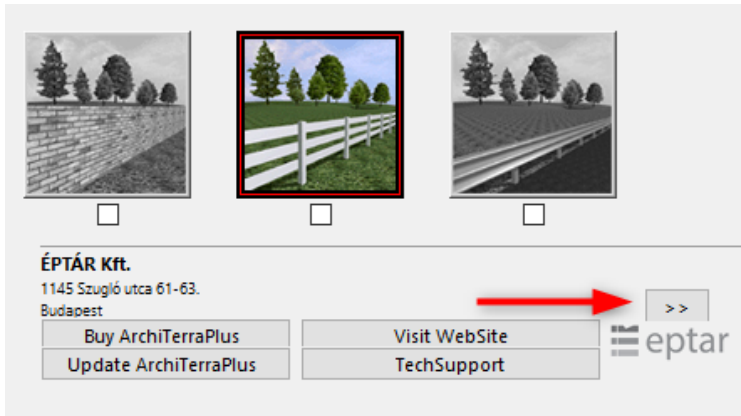

Fence function

By choosing this function in the main key panel and then click on the settings definition button, a dialog box to customize the fence will appear.

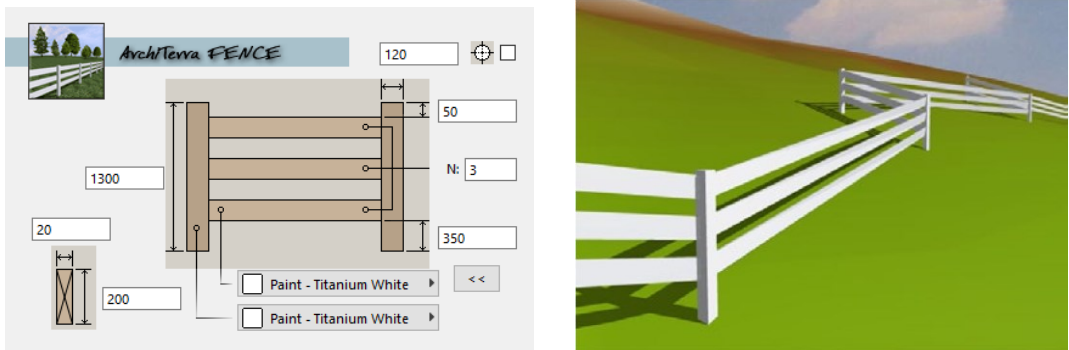

The user can configure the altitude and size (side or diameter) of the vertical elements and choose whether they are square or round.

It also can be defined the number of horizontal elements (N field) and their offset from the base and top and the size of their cross section.

Two pop-up menus allow to define the surface material for the horizontal and vertical elements.

NOTE:

In this case, the thickness and height defined by the ArchiTerraPlus Wall settings dialog box are irrelevant as the thickness and height of the fence depends on the configuration in the Object settings dialog (side/diameter of vertical elements).

TIP:

The vertical elements correspond to the nodes of the polyline used to generate the wall element, so when the user want to create a fence, she/he are consequently defining the nodes of the polyline.

In the two following examples, it is possible to see how the number of uprights changes according to the nodes on the polyline used:

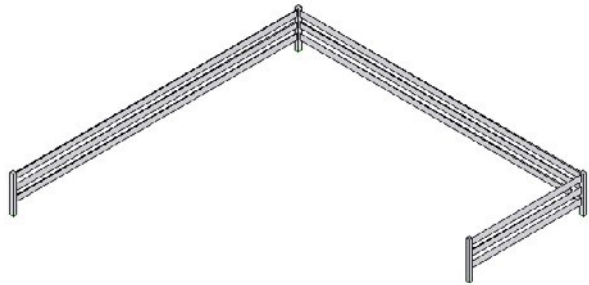
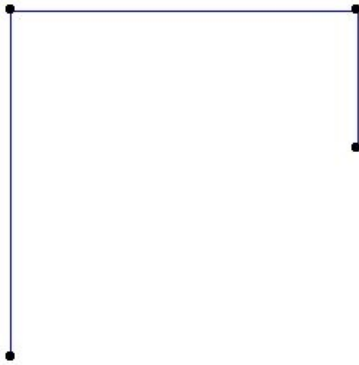

A polyline with four nodes generates a fence with four uprights.

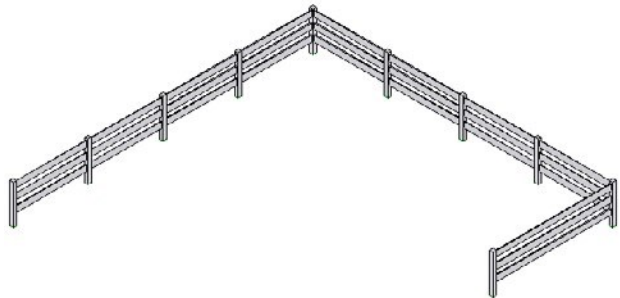
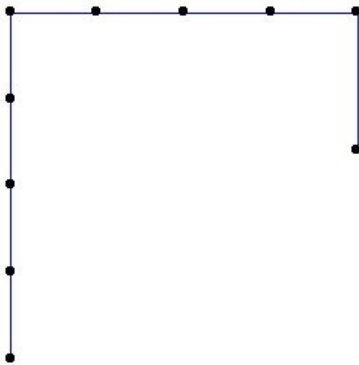

A polyline with ten nodes generates a fence with ten uprights.

Guardrail function

By choosing this function in the main key panel and then click on the settings definition button, a dialog box to customize the guardrail will appear.

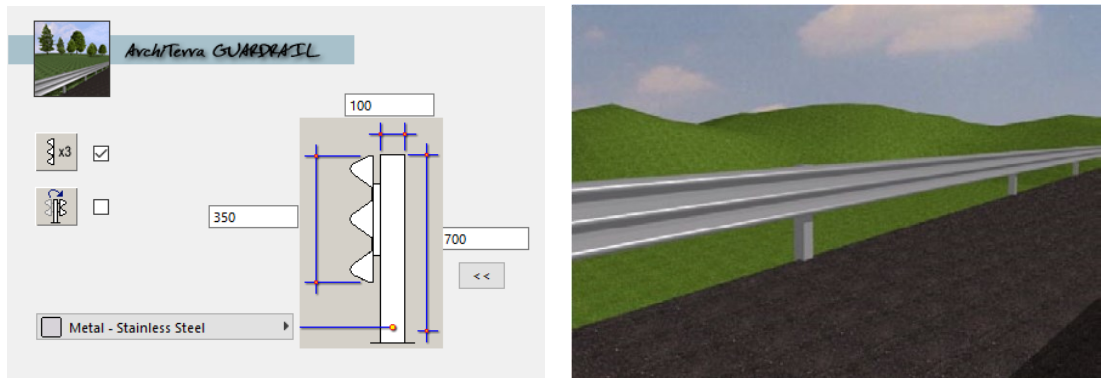

The user can configure the height and size of the vertical elements.

It also can be configured the height of the barrier if it is made up of two or three elements and the side on which it is inserted.

A pop-up menu allows the surface material to be defined.

NOTE:

In this case, the thickness and height defined by the ArchiTerraPlus Wall settings dialog box are irrelevant as the thickness and height of the guardrail depends on the configuration in the Object settings dialog (side/diameter of vertical elements).

Tip:

The vertical elements correspond to the nodes of the polyline used to generate the wall element, so when the user want to create a guardrail, she/he are consequently defining the nodes of the polyline.

In the two following examples, it is possible to see how the number of uprights changes according to the nodes on the polyline used:

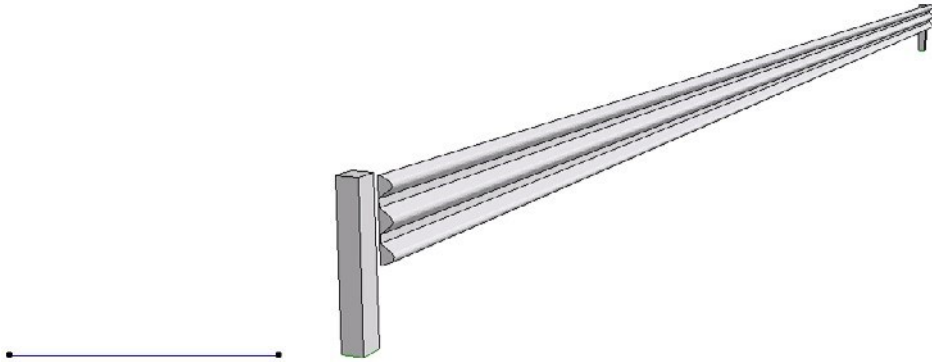

A polyline with two nodes generates a guardrail with two uprights.

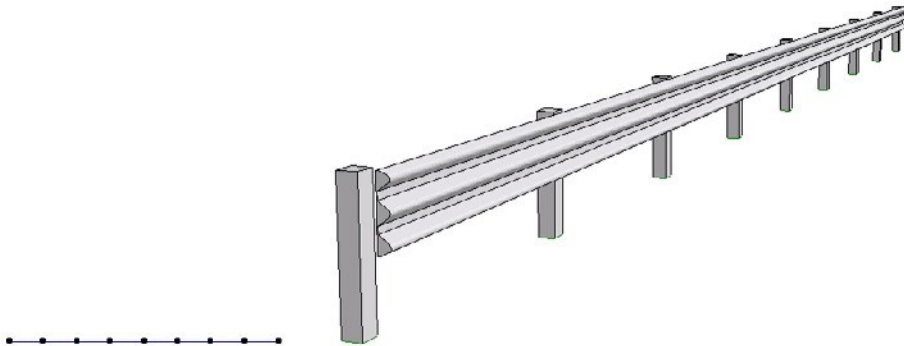

A polyline with nine nodes generates a guardrail with nine uprights.

Customizing trunks and leaves

By using the following tips and a little imagination and application, the user can further customize their random trees by generating trunks/branches and fronds according to their taste.

Trunks

As already seen, ArchiTerraPlus already includes several trunk/branch styles:

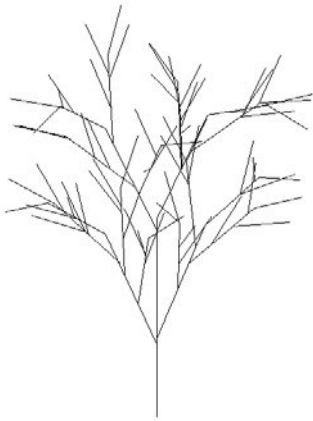

Style 1 Lines

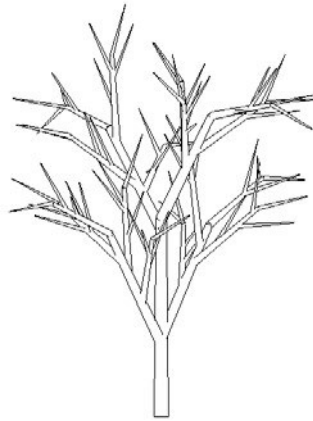

Style 2 Cylinders

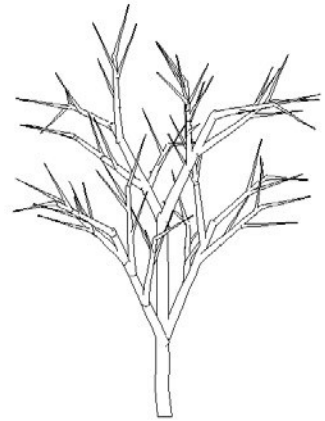

Style 3 Trunk

These three styles correspond to three GDL objects used by the SS_TREE object to generate the trunk and branches:

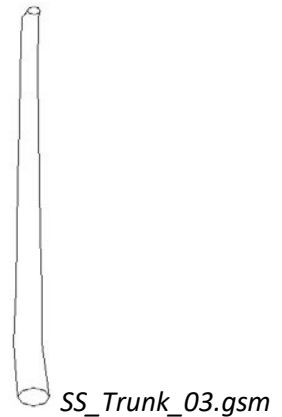
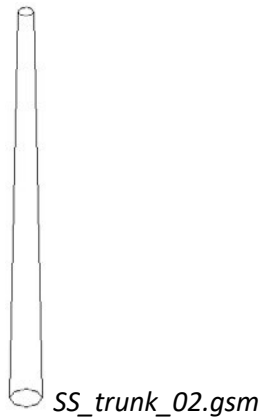
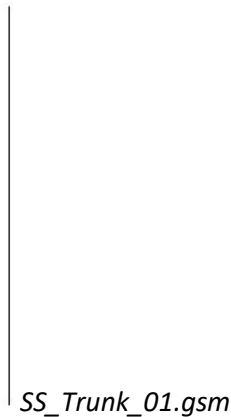

Now we will try and create a custom trunk without using GDL programming.

Spiral trunk

Let's try and create a strange tree with trunk and branches consisting of spirals. Without using GDL, we will take an element present in the standard ARCHICAD library, the spiral.

Configure the parameters of the object to obtain a result similar to the following:

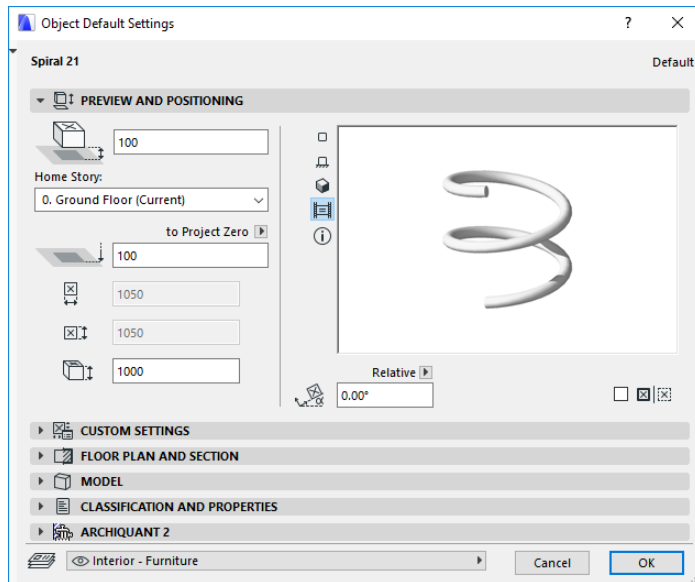

Now let's display an object with the following settings as a plan from above in the 3D view:

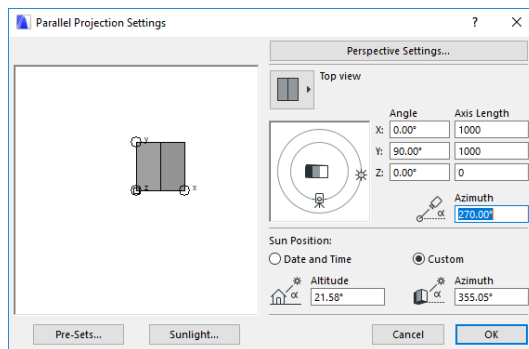

The 3D view will appear as follows:

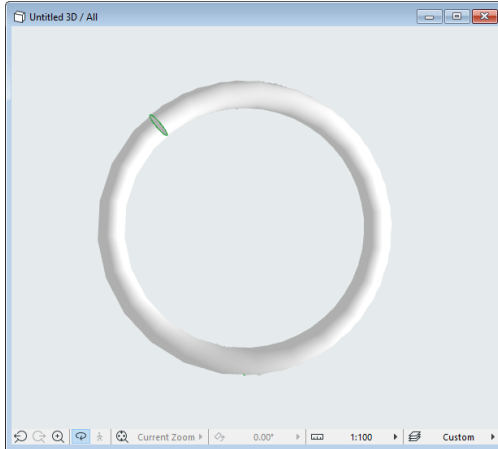

With the 3D view at the front, from the File menu choose the GDL Objects.../Save 3D Model as... command.

In the save box which appears, enter a name for the object and choose to save it (we suggest to use the Trunk styles folder in the ArchiTerraPlus library), confirming with the OK button.

In the subsequent dialog, select the object format icon and activate the non-editable 3D Binary Format option, then click on the Save button.

The first part is over, and the object must now be modified to make it a custom trunk/branch in the ArchiTerraPlus library. From the File menu, choose the GDL Objects.../ Open Object... command and select the spiral branch just saved to modify it.

ARCHICAD will open the library element editing window.

At the top right, click on the Select Subtype button... and in the list which appears select the SS_Trunk_Subtype subtype (in the Model Element item), then confirm the choice with the Select button.

Now it must add a number of GDL texts (always the same, don't worry!). In the Master text window (which will be empty), add the following two lines:

```
A=raggio_1 B=raggio_1
```

At the beginning of the 3D GDL Text box, add the following lines:

```
ADD -A/2, -B/2, 0
```

```
MATERIAL mat
```

At the bottom of the GDL text, find the command `BINARY 0, 1` and replace the first 1 with a zero:

```
BINARY 0, 1
```

Finished!

Record the modifications to the spiral branch and it is ready to use it.

Now generate a random tree (as described in the relevant chapter) and in the Trunk and Leaf Style section:

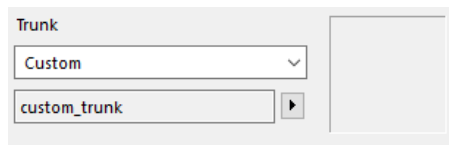

Select the custom style option in the trunk style pop-up menu, then by clicking on the arrow button on the right, select the spiral branch.

Confirm the modifications with the OK button and here is the tree, consisting of a series of spirals in place of the trunk and branches:

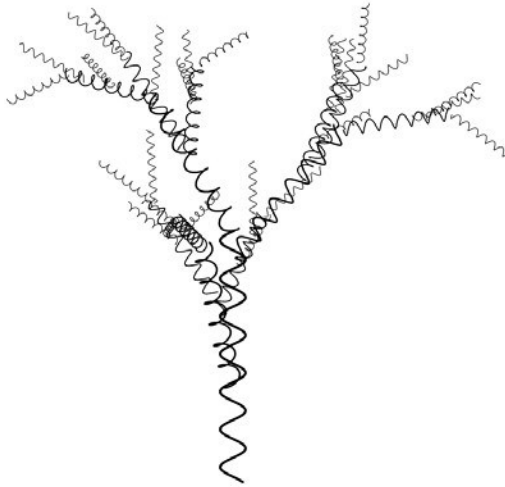

NOTE:

Experts in GDL programming will obviously be able to obtain much more satisfactory results. Take a look at the script for the three pre-defined trunk styles to understand how they work.

Leaves

As already seen, ArchiTerraPlus already includes a number of leaf frond styles:

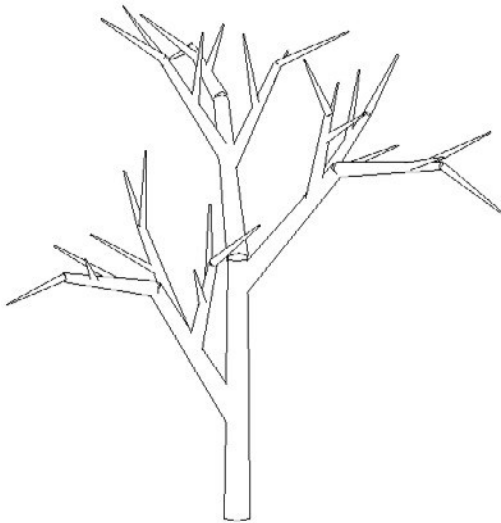

Without leaves



Style 1



Style 2

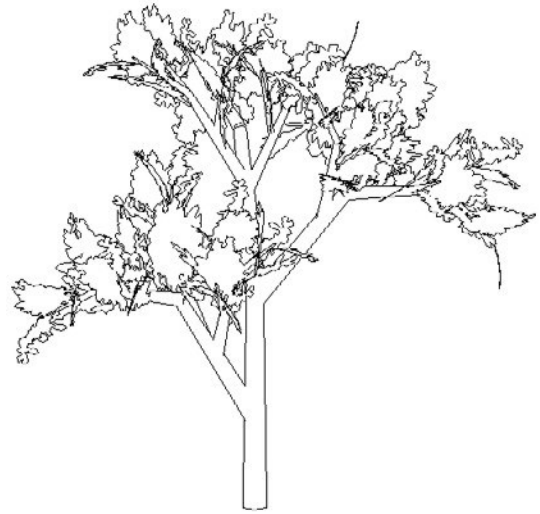

Style 1+2

These three styles correspond to three GDL objects used by the SS_TREE object to generate the fronds:



SS_Leaves_00.gsm



SS_Leaves_02.gsm

SS_Leaves_01.gsm

Now we will try and create a custom frond without using GDL programming.

Star frond

Let's try and create a strange tree with star-shaped fronds. Use a zero-thickness ARCHICAD slab to draw the star:

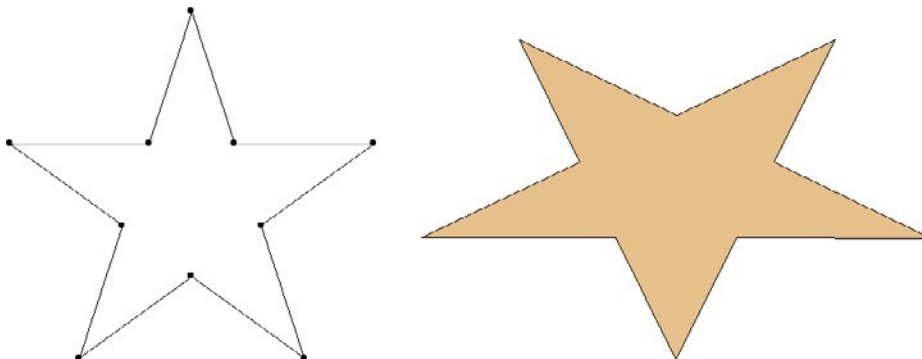

Select it and view a plan from above of the slab in the 3D view with the following settings:

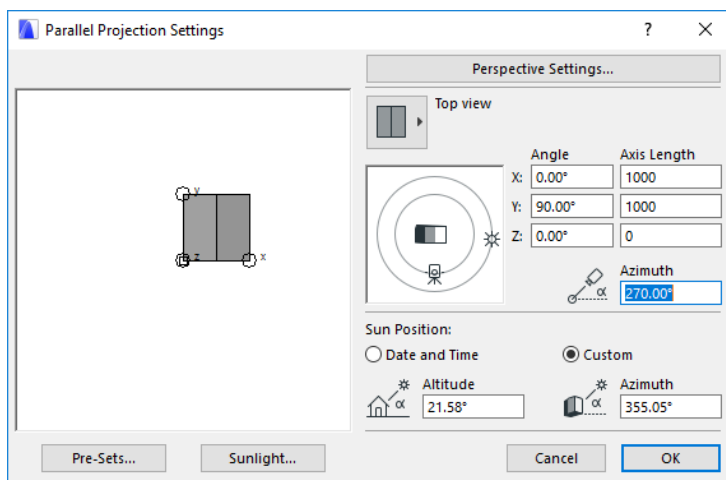

The 3D view will appear as follows:

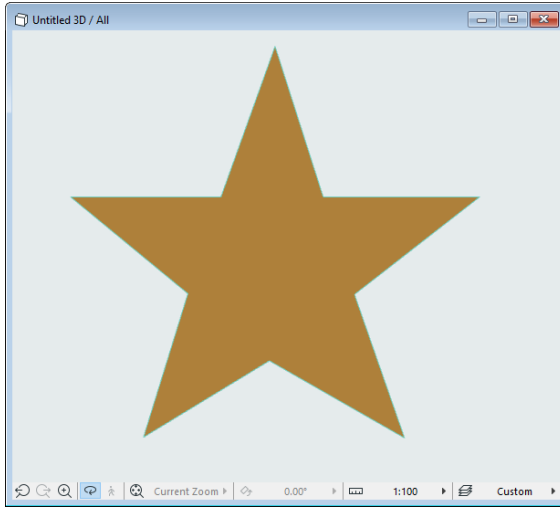

With the 3D view at the front, from the File menu choose the GDL Objects.../ Save 3D Model as... command.

In the save box which appears, enter a name for the object and choose to save it (we suggest to use the Leaves styles folder in the ArchiTerraPlus library), confirming with the OK button. In the subsequent dialog, select the object format icon and activate the non-editable 3D Binary Format option, then click on the Save button.

The first part is over, and the object must now be modified to make it a custom frond in the ArchiTerraPlus library. From the File menu, choose the GDL Objects.../Open Object... command and select the star frond just saved to modify it.

ARCHICAD will open the library element editing window. At the top right, click on the Select Subtype button... and in the list which appears select the SS_Leaves_Subtype subtype (in the Model Element item), then confirm the choice with the Select button.

Now it must add a few GDL texts (always the same, don't worry!).

At the beginning of the 3D GDL Text box, add the following line:

```
ADDx -A/2
```

At the bottom of the GDL text, find the command BINARY 1, 1 and you should replace the first 1 with a zero:

```
BINARY 0, 1
```

Finished!

Save the modifications to the star frond and it is ready to use it. Now generate a random tree (as described in the relevant chapter) and in the Trunk and Leaf Style section.

Select the custom style option in the leaves style pop-up menu, then by clicking on the arrow button on the right, select the star frond.

Confirm the modifications with the OK button and here is the tree, consisting of a series of star fronds:



Problems with Solid Elements Operations

As already described several times in this manual, all the modelling operations performed on the terrain use Solid Elements Operations.

The shapes used to model the terrain can be extremely complex for ARCHICAD and sometimes (depending on the version used as Graphisoft continues to improve the Solid Elements Operations calculation engine), errors may occur which prevent modelling of the terrain as requested.

We always recommend enabling interruption for error messages to have immediate feedback on the error. In any case, if the Solid Elements Operation is not successful, it will be possible to realize immediately as the terrain will not be modelled, will be partially modelled or there will be errors. To avoid this problem, proceed as follows:

1. Try slightly varying the altitude of the operation (the altitude of the plateau or the altitudes of individual nodes of the road).
2. Modify the angle of the scarps until the operation is successful (if the error is caused by the shape of a scarp, it can usually be resolved by using an angle creating a steeper scarp).
3. Reduce or increase the resolution of curves (it is usually best to unlink this value) modify the scarp continuation value.
4. It is, however, difficult to give a general solution as it depends on the specific shape of the terrain and the element involved.

SOSI Files Import *(multiple files import option)*

For those who works with Norwegian ARCHICAD or in the Norwegian region, ArchiTerraPlus has one more feature: The SOSI import files.

SOSI files are geospatial vector data format predominantly used in Norway and it means in English “Coordinate Approach for Spatial Information”. In other words, with SOSI files it is possible to import more data besides just the terrain, such as buildings, roads, fences, etc.

By clicking in the Acquisition of the Terrain button, the user will find below the mesh icon the SOSI import icon.

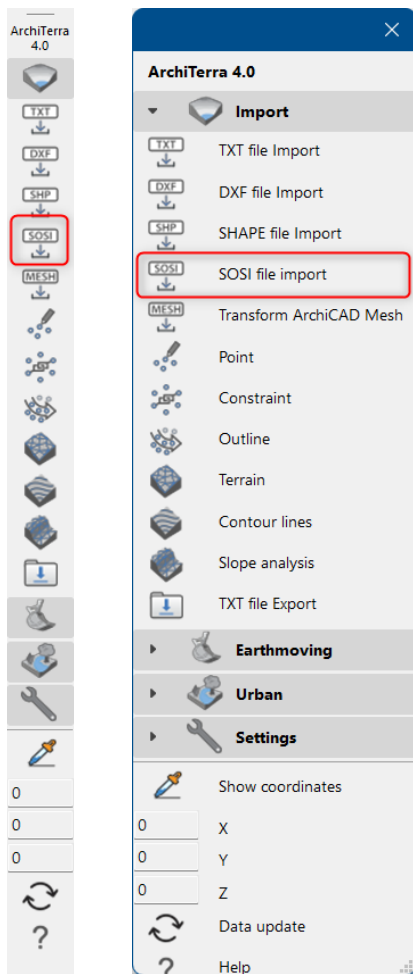

By clicking on this tool, the dialog window comes up and there will be 3 options to import those files: using an independent worksheet, as terrain survey and converting SOSI entities to GDL objects.

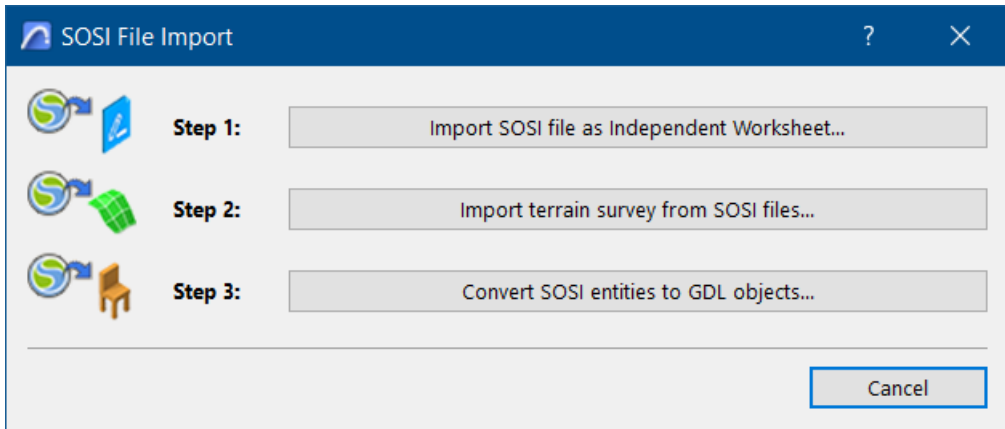

Independent Worksheet

By clicking in the step 1 a standard open dialog box will appear where the user can select the SOSI file to import directly to the worksheet.

The *SOSI File Import dialog box* will open then, enabling to choose the layers to import and other settings.

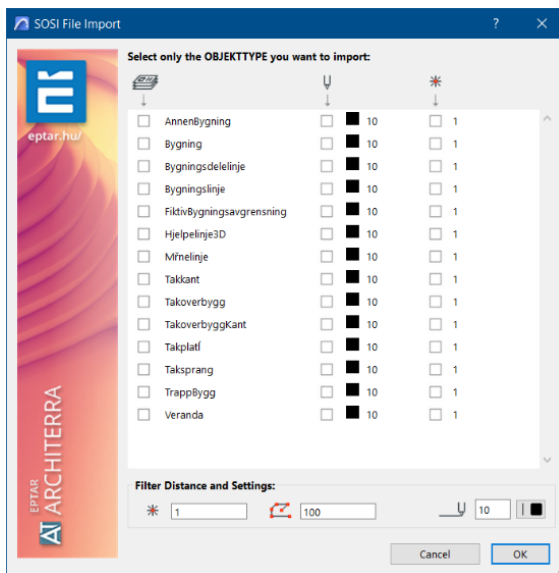

In this dialog box the user can select the filter distance and settings, the reference ID, and the name of the worksheet.

After the changes the import results dialog box will display showing the coordinates and the number of import results, similar with the one in the Text Files.

There is also the option of limited import, where the user can define values for the coordinates (Xmin, Ymin, Xmax and Ymax).

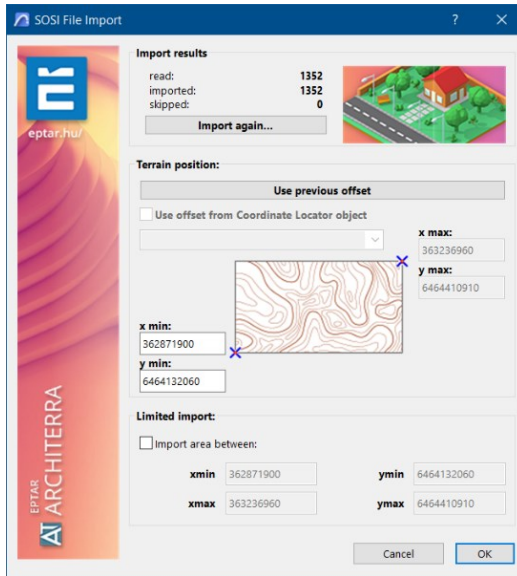

By checking the worksheet, it will be able to see that the ArchiTerraPlus tool palette has some available icons. By clicking in the Acquisition of Terrain Data again, the user can import another file to this same worksheet.

This time, it will not be possible to add another ID and name to the worksheet, considering that is the same worksheet previously created.

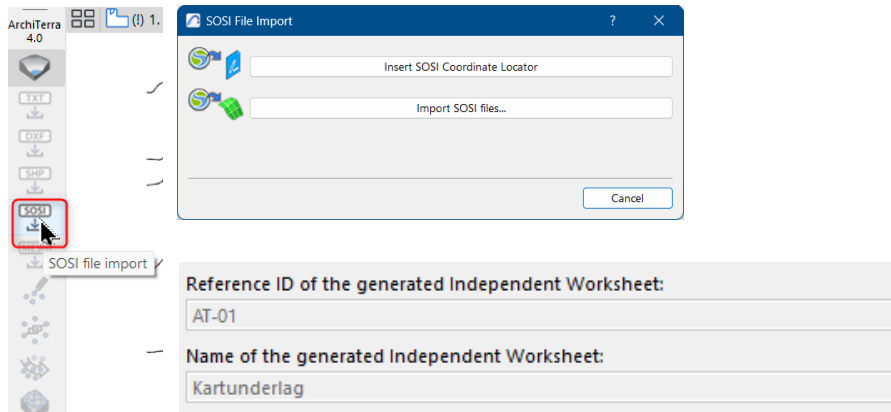

The user can also insert objects by clicking in the first button of the Acquisition of Terrain Data in the worksheet.

A new standard open dialog box will appear, similar with ARCHICAD object dialog box and there the user can select the objects from the ArchiTerraPlus Library.

Terrain Survey to SOSI file

With this option, the user can import the SOSI files to the workspace and then use the other tools from ArchiTerraPlus palette.

The process is like the previous step. A standard open dialog box will appear enabling to choose the SOSI file.

Once select a *SOSI Import dialog box* will show the layers and settings. In this case, the user can link the layers, like in the Text files.

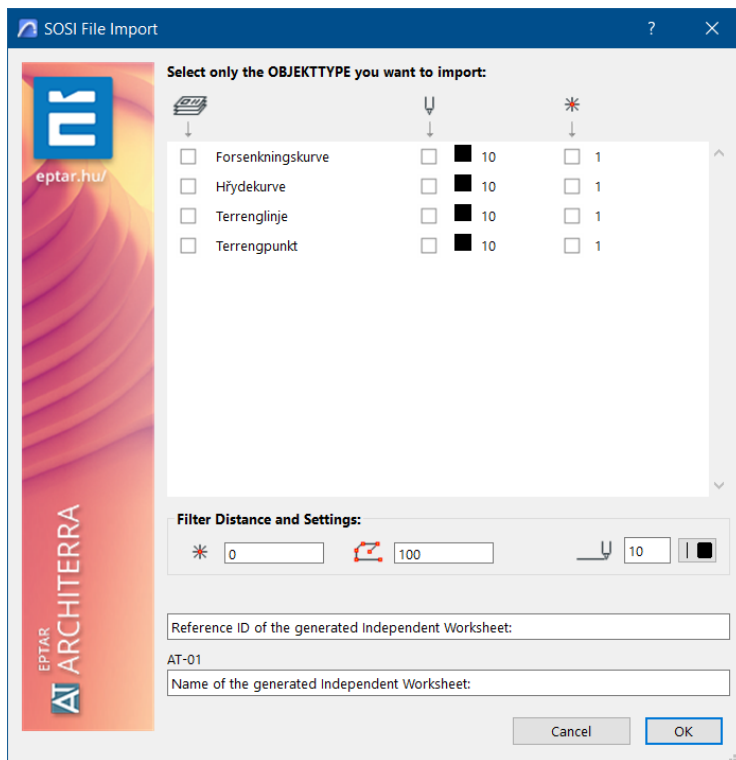

By selecting the layers, filter distance and settings, the import results dialog box with the number of imported data will open.

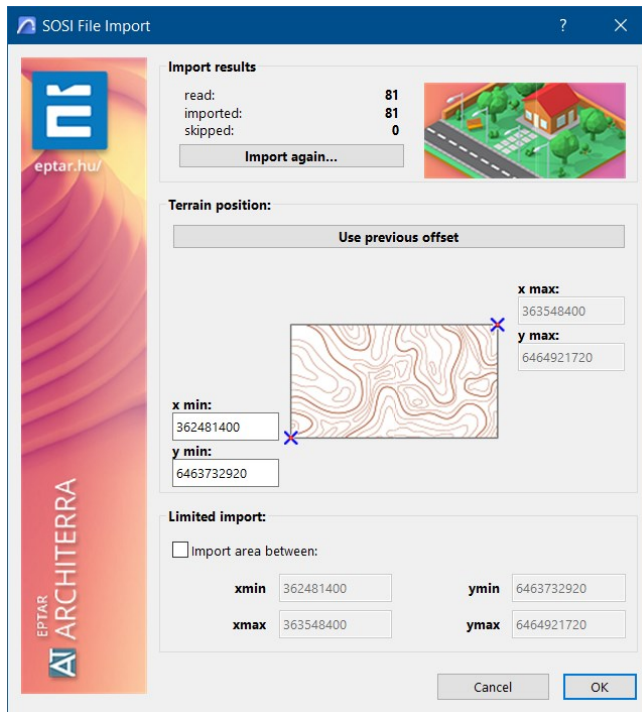

In this case, the user can use the same coordinates as used for the worksheet before (if it was created one) or choose new values. The user can also add and altitude filter for their imported data, considering the first altitude and the final, besides the equidistance between the points.

When the user click ok the same SOSI dialog box from the step 1 appear to choose the coordinates again. Then click ok. The points will be displayed in the worksheet.

Convert SOSI entities to GDL objects

In this step the data what the user needs to import will placed in the worksheet as a GDL object, with hotspots and polylines and not points representing coordinates like in the previous steps.

For create these objects, click on the step 3, and select the file to import. Then choose the desired layers to import. The similar dialog boxes from the steps 1 and 2 will open and it will be able to select the layers and setting in the first and the coordinates in the second.

Then the ARCHICAD object window will open. In this part the user will be able to choose how would like to represent the object in the worksheet, as a 3D polygon, 3D surfaces or 3D solid.

Then just click Ok.

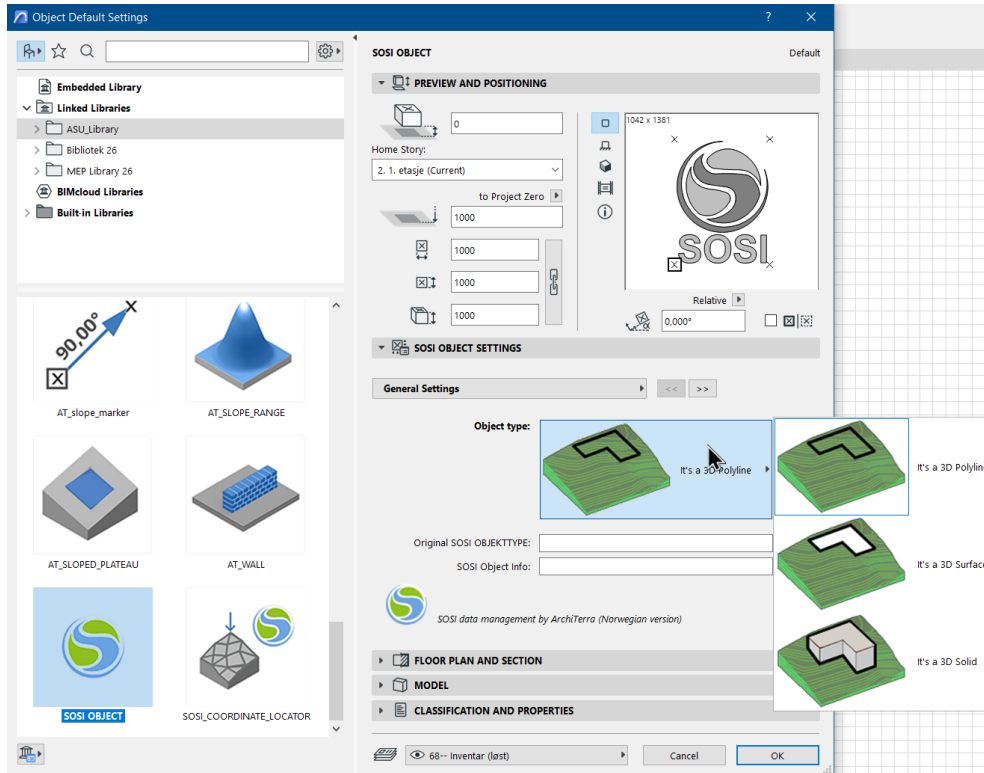

As a result, the terrain and different objects (buildings, roads, etc) will be converted from SOSI data into the 3D models.